

# TAYLOR TUBES Are Sold Through Distributors

There is a TAYLOR TUBE Distributor in every logical distribution point throughout the United States and in many foreign countries. It has been made possible for Industrial and Broadcast Engineers and Amateur Radio Operators easily to obtain almost any type of TAYLOR TUBE listed in this catalog. This is because the distribution is limited so that each Distributor has a sufficiently large market to enable him to carry a *complete* line of TAYLOR TUBES.

Every TAYLOR TUBE Distributor has been selected with full consideration of his proven

ability as well as his reputation for fair dealing. It is a matter of pride that TAYLOR TUBE Distributors not only sell our product—they recommend it above *all others*.

The TAYLOR TUBE Distributor in your area is the best source for complete technical information on Electronic Tubes and Apparatus. He will give you prompt service on your requirements.

We welcome the opportunity to send you the name of the *leading* radio parts house in your vicinity. There is a TAYLOR TUBE Distributor near you!

## TAYLOR TUBE RATINGS HAVE FCC APPROVAL

*Taylor Tubes Are Licensed by RCA and G. E.*

# INDEX

	Page		Page
873	2	813	17
TT-17	3	803	18
875-A	4	203-Z	19
872-A	4	838	19
866-A	5	T-20	20
249-B	6	TZ-20	21
866 Jr. (2B26)	6	T-55	22
822-822S	7	T-60	23
T-40	8	T-100	23
TZ-40	9	830-B	23
810	10	TR-40M	23
T-125-T-124	11	814	24
T-200	12	841-SW	24
805	13	HD-203A	24
203-A	14	HD-211C	24
211-211-D	14	General Tube Information	25 to 31
211-C	15	How To Choose A Tube	25
845	15	L/C Ratio	28-29
T-21	16	Rectifier Information	31
282-A	16	Interchangeability Chart	32

# Taylor

CUSTOM  
BUILT

# Tubes



FRANK J. HAJEK, W9ECA  
*President*



REX L. MUNGER, W9LIP  
*Sales Manager*

## “TAYLOR TUBES”—ASK ANY ELECTRONIC ENGINEER!

TAYLOR TUBES, Inc., presents this 1945 edition of its famous Tube Manual to Radio Engineers and Technicians in the Armed Services and the War Industries with the hope that the complete, up-to-date information and technical data will prove helpful in the selection of the right tube for each application and to obtain the highest efficiency from the tube itself. More complete information on each standard type is available, and your inquiries are invited on those or any special types.

The TAYLOR TUBE Engineering Department is geared to provide fast action for you on any special tube problem or requirement.

TAYLOR TUBES is bending every effort to meet Military and Naval requirements. Its facilities have been expanded 100% and its thoughts are devoted to the greatly increased production and improved quality of electronic tubes for the Services.

After our Victory is achieved, TAYLOR TUBES will offer tubes in a widely extended utility range. TAYLOR TUBES, Inc., has since 1936 maintained constant leadership in bringing its customers new values.

TAYLOR TUBES WILL CONTINUE TO SET THIS PACE!



JOSEPH F. HAJEK  
*Secretary*

**TAYLOR  
TUBES  
ARE  
ALL OUT FOR  
VICTORY!**



JERRY WOREL  
*Treasurer*

# Taylor

**CUSTOM BUILT**

# Tubes

## 873

**GRID CONTROL MERCURY VAPOR  
RECTIFIER**

**REPLACES 973 AND FG-27**

### \$17.25



## 873

Grid control Rectifier tubes (thyatrons) are the most versatile of electronic tubes. The wide range of usefulness of these tubes is due to remarkable sensitivity, high operating speed, great durability as a rapid-duty contactor and general adaptability to automatic operations. The Taylor 873 has a wide range of uses in the newer industrial electronic apparatus. The new, more rugged design insures successful operation under the most difficult conditions.

#### GENERAL CHARACTERISTICS

Number of Electrodes.....	3
Filament—Cathode Coaxial:	
Voltage, volts.....	5.0
Current, amps.....	6.75
Heating Time, sec.....	45

#### Single Phase—Half-Wave Circuit—1 Tube

<b>Anode Voltage:</b>	
Maximum Peak Inverse Voltage, volts.....	3000
Maximum Peak Forward Voltage, volts.....	3000

<b>Maximum Anode Current:</b>	
Instantaneous, amps.....	10.0
Average, amps.....	2.5
Surge (should not last longer than 1 sec.), amps.....	90.0

#### Single Phase—Full Wave Circuit—2 Tubes

<b>Anode Voltage:</b>	
Maximum Peak Inverse Voltage per tube, volts.....	10000
Maximum Peak Forward Voltage per tube, volts.....	3000

<b>Maximum Anode Current:</b>	
Instantaneous per tube, amps.....	10.0
Average per tube, amps.....	1.25
Surge (should not last longer than 1 sec.), amps.....	90.0

<b>Maximum Time of Averaging Anode Current, sec.....</b>	15
--	----

<b>Maximum Grid Current:</b>	
Instantaneous, † amps.....	1.0
Average, amps.....	25

<b>Tube Voltage Drop, volts.....</b>	10-15
--------------------------------------	-------

<b>Approximate Starting Characteristics at Cond. Mercury Temp. of 50° C.</b>		
D. C. Anode Voltage	Grid Voltage	
70	0	
100	-3	
1000	-5.5	

<b>Temperature Limits:</b>	
Condensed Mercury Temperature.....	40 to 80 C
Ambient Temperature Range.....	25 to 65 C
Defolentization Time—approximate.....	1000 microsec
Ionization Time.....	10 microsec

<b>Dimensions:</b>	
Maximum Length.....	8 1/2"
Diameter.....	2 1/8"
Bulb.....	T-16
Cap.....	Medium metal
Type of Coating.....	Air
Base.....	4 Pin Jumb

The filament should be allowed to come up to operating temperature before the plate voltage is applied.  
 †When operating at a frequency of less than 25 cycles, the maximum instantaneous current is reduced to twice the average current rating.  
 Return leads from anode and grid circuits should be connected to the center tap of the filament transformer winding when A.C. is used on the filament. If D.C. is used the return should be made to the negative filament terminal.

The defolentization time of this type of tube is too long to allow it to be used with satisfaction for inverter circuits.

All mercury vapor or gas filled tubes require protective resistances in the grid and anode circuits to limit the current in these circuits to the rated value.

#### INSTALLATION

The base of the Taylor 873 is designed for mounting in a standard "50 watt" socket. The tube should always be mounted vertically with ample air space provided for ventilation. The ambient temperature should not be less than 25° C (77° F) and not more than 65° C (149° F) for the maximum peak inverse voltage. When the maximum ambient temperature exceeds these limits, forced ventilation should be used.

The filament of the 873 should be operated on alternating current at the rated value of 5.0 volts. The socket should make good contact to the tube pins and adequate current-carrying capacity leads to the secondary winding of the power transformer should be used. Operation of the filament at less than the rated voltage may result in a high internal voltage drop with subsequent loss of emission. A filament voltmeter should be connected permanently across the filament circuit at the socket terminals in order that the filament voltage can be maintained at 5.0 volts.

Because the mercury may be splashed on the tube elements due to shipment or handling, the filament of the 873 should be operated at rated voltage for approximately 3 minutes without plate voltage in order to distribute the mercury properly when the tube is first placed in service. The above procedure need not be repeated unless the tube is removed from the socket and during handling the mercury becomes splashed on the tube elements.

The condensed mercury temperature should be at least 25° C before the plate voltage is applied. This may be ordinarily accomplished by introducing a time lag of at least 45 seconds between the application of the filament and the plate voltages. In event that arcbreak should occur when the plate voltage is applied, the pre-heating time of the filament should be increased.

When the 873 is subjected during operation to external high voltage or high frequency fields, shielding and R-F filter circuits should be provided.

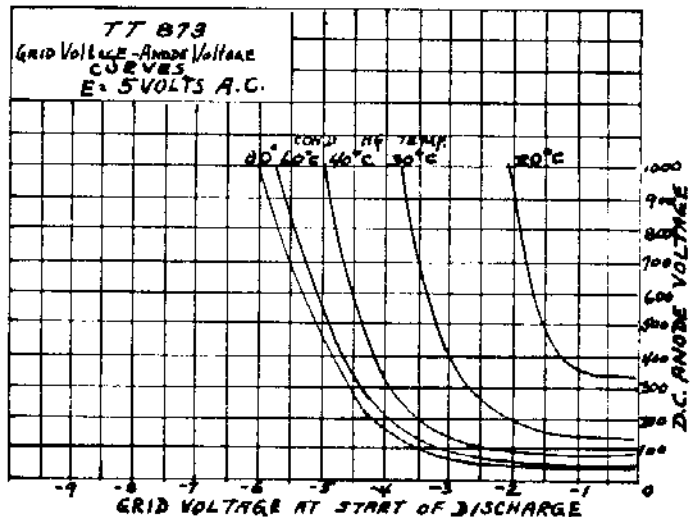

## TT-17

Grid control rectifier tubes (thyretrons) are the most versatile of electronic tubes. The wide range of usefulness of these tubes is due to remarkable sensitivity, high operating speed, great durability as a rapid-duty contactor and general adaptability to automatic operations. The Taylor TT-17 has a wide range of uses in the new industrial electronic apparatus. The new, more rugged design insures successful operation under the most difficult conditions.



## TT-17

**GRID CONTROL MERCURY VAPOR  
RECTIFIER  
REPLACES FG-17 AND 967 TYPES**

**\$6.00**

### INSTALLATION

The base of the Taylor TT-17 is designed for mounting in a standard four-prong socket. The tube should always be mounted vertically with ample air space provided for ventilation. The ambient temperature should not be less than 25° C (77° F) and not more than 65° C (149° F) for the maximum peak inverse voltage. When the maximum ambient temperature exceeds these limits, forced ventilation should be used.

The filament of the TT-17 should be operated on alternating current at the rated value of 2.5 volts. The socket should make good contact to the tube pins and adequate current-carrying capacity leads to the secondary winding of the power transformer should be used. Operation of the filament at less than the rated voltage may result in a high internal voltage drop with subsequent loss of emission. A filament voltmeter should be connected permanently across the filament circuit at the socket terminals in order that the filament voltage can be maintained at 2.5 volts.

Because the mercury may be splashed on the tube elements due to shipment or handling, the filament of the TT-17 should be operated at rated voltage for approximately 3 minutes without plate voltage in order to distribute the mercury properly when the tube is first placed in service. The above procedure need not be repeated unless the tube is removed from the socket and during handling the mercury becomes splashed on the tube elements.

The condensed mercury temperature should be at least 25° C before the plate voltage is applied. This may be ordinarily accomplished by introducing a time lag of at least 30 seconds between the application of the filament and the plate voltages. In event that arc-back should occur when the plate voltage is applied, the pre-heating time of the filament should be increased.

When the TT-17 is subjected during operation to external high voltage or high frequency fields, shielding and R-F filter circuits should be provided.

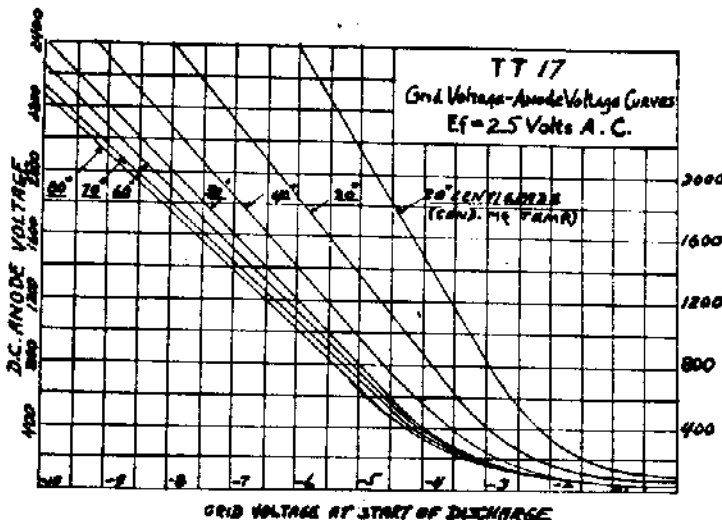

### GENERAL CHARACTERISTICS

Number of Electrodes.....	3
Filament—Oxide Coated:	
Voltage, volts .....	2.5
Current, amps. ....	3.0
Heating Time, approx., sec.....	5

#### Single Phase—Half-Wave Circuit—1 Tube

<b>Anode Voltage:</b>	
Maximum Peak Inverse Voltage, volts.....	2500
Maximum Peak Forward Voltage, volts.....	2500
<b>Maximum Anode Current:</b>	
Instantaneous, amps. ....	2.0
Average, amps. ....	.50
Surge (should not last longer than 1 sec.), amps.....	20

#### Single Phase—Full-Wave Circuit—2 Tubes

<b>Anode Voltage:</b>	
Maximum Peak Inverse Voltage per tube, volts.....	7500
Maximum Peak Forward Voltage per tube, volts.....	2500
<b>Maximum Anode Current:</b>	
Instantaneous per tube, amps. ....	2.0
Average per tube, amps. ....	.25
Surge (should not last longer than 1 sec.), amps.....	20
Maximum Time of Averaging Anode Current, sec.....	15
<b>Maximum Grid Current:</b>	
Instantaneous, † amps. ....	.25
Average, amps. ....	.05
Tube Voltage Drop, volts.....	10-24

#### Approximate Starting Characteristics:

D. C. Anode Voltage	Grid Voltage
30	0
100	-2.25
1000	-5.0

#### Temperature Limits:

Condensed Mercury Temperature.....	40 to 80 C
Ambient Temperature.....	25 to 65 C
Deionization Time—approximate.....	1000 microsec
Ionization Time.....	10 microsec

#### Dimensions:

Maximum Length .....	.658"
Diameter .....	.275"
Bulb .....	S-19
Cap .....	Medium metal
Base.....	Medium 4 pin bayonet
Type of Cooling.....	Air

\* The filament should be allowed to come up to operating temperature before the plate voltage is applied.

† When operating at a frequency of less than 25 cycles, the maximum instantaneous current is reduced to twice the average current rating.

Return leads from anode and grid circuits should be connected to the center tap of the filament transformer winding when A-C is used on the filament. If D-C is used the return should be made to the negative filament terminal.

The deionization time of this type of tube is too long to allow it to be used with satisfaction for inverter circuits.

All mercury vapor or gas filled tubes require protective resistances in the grid and anode circuits to limit the current in these circuits to the rated values.

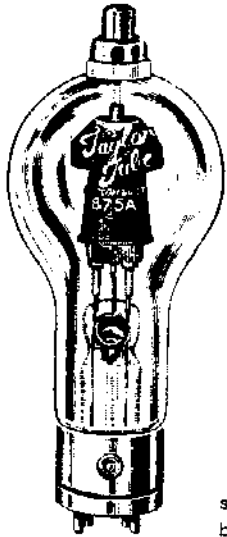

## 875-A

**CARBON ANODE AND SHIELD  
HALF-WAVE  
MERCURY VAPOR  
RECTIFIER TUBE**

*For Broadcast Stations and  
Induction Heating Apparatus*

**\$30.00**

This new and greatly improved Taylor design incorporates the use of a Processed Carbon Anode and shield. This type is widely used in commercial services. A performance test will thoroughly prove the superiority of Taylor's 875-A's.

**GENERAL CHARACTERISTICS**

Filament Volts .....	5
Filament Current, amps.....	10
Heating time, seconds.....	30

**Overall Dimensions**

Maximum Height, inches.....	10 3/4
Maximum Diameter, inches.....	3 1/8
<b>50 Watt Base</b>	<b>Nonex Glass</b>

**Max. Peak Inverse Voltage**

Condensed Mercury Temperature 20° to 50° C.....	15,000
Condensed Mercury Temperature 20° to 60° C.....	10,000
Max. Peak Plate Current, amps.....	6
Max. Average Plate Current, amps.....	1.5
Approx. Tube Voltage Drop, volts.....	10

**TYPICAL CIRCUIT—MAXIMUM CONDITIONS**

	R.M.S. Input Volts	Max. D.C. Output Volts	Amps.
Single phase full wave (2 tubes).....	5300	4750	3
Single phase bridge (4 tubes).....	10600	9500	3
Three phase half wave (3 tubes).....	6120	7150	4.5
Three phase parallel double Y (6 tubes).....	6120	7150	9
Three phase full wave (6 tubes).....	6120	14300	4.5

**Special Note**

In transit mercury in tube splatters over filament—therefore when first placing this tube into operation filament should be lighted for fully 15 minutes to allow mercury to condense to bottom of bulb.

**HALF-WAVE  
MERCURY VAPOR  
RECTIFIER TUBES**

*New Low Price!*

**872-A — 8008**  
**\$7.50      \$7.00**



This new and greatly improved Taylor design incorporates the use of a Processed Carbon Anode and shield. Tried and proven in actual broadcast station use. A performance test will thoroughly prove the superiority of Taylor 872-A's. In a single phase full wave rectifier, with choke input, two 872-A's will deliver up to 2.5 amps. at 3200 volts D.C. Multi-strand filament. Ratings for the 872-A and 8008 are identical.

**GENERAL CHARACTERISTICS**

Filament Volts .....	5
Filament Current, amps.....	6.75
Heating Time, seconds.....	30

**Overall Dimensions**

Maximum Height, inches .....	8 3/4
Maximum Diameter, inches .....	2 1/8
	<b>Nonex Glass</b>

872-A has a standard 50 watt base. The 8008 has the industrial type long prong 50 watt base—fits a Johnson No. 244 socket.

**Max. Peak Inverse Voltage**

Condensed Mercury Temperature 20° to 60° C.....	10,000
Condensed Mercury Temperature 20° to 70° C.....	5,000
Max. Peak Plate Current, amps .....	5.0
Max. Average Plate Current, amps .....	1.25

**TYPICAL CIRCUIT—MAXIMUM CONDITIONS**

	R.M.S. Input Volts	Max. D.C. Output Volts	Amps.
Single phase full wave (2 tubes).....	3530	3150	2.5
Single phase bridge (4 tubes).....	7060	6360	2.5
Three phase half wave (3 tubes).....	4080	4780	3.75
Three phase parallel double Y (6 tubes).....	4080	4760	7.5
Three phase full wave (6 tubes).....	4080	4780	3.75

**Special Note**

In transit mercury in tube splatters over filament—therefore when first placing this tube into operation filament should be lighted for fully 15 minutes to allow mercury to condense to bottom of bulb.

The single-phase half-wave circuit of Figure 1 is not very popular due to the fact that the ripple is of greater magnitude and being of lower frequency than other systems is more difficult to filter. With choke input, the DC voltage will be approximately .45 that of the r.m.s. voltage E. Figure 2 illustrates the full-wave single-phase circuit which every amateur is familiar with. Figure 3 is identical in nature with Figure 2, except that four tubes (more if desired) are used to obtain higher current output. The resistors shown in the plate circuits of these tubes are very essential, otherwise one tube will generally take most of the load with the natural result that the tube life is greatly decreased; a drop of about six volts across these resistors will insure stability. Figure 4 shows a bridge circuit with four tubes, its advantage is that high DC voltages can be secured without expensive (high peak inverse voltage) tubes and with low voltage transformers. For full-wave rectification the DC voltage can be increased by using the entire secondary output of the plate transformer, in fact, the voltage will be exactly doubled; of course, this halves the current output due to the transformer current carrying limitations. Figures 5 and 6 are similar to that of Figure 2, except that they apply to three-phase circuits. In the circuit of Figure 5, each tube carries current for one-third cycle. The circuit of Figure 6 is very commonly employed in high power transmitters where three-phase power is available due to the high DC output voltage attained. This circuit has the added advantage that the ripple frequency is high, being six times the supply frequency, allowing simple filtering.



## 866-A HALF-WAVE MERCURY VAPOR RECTIFIER

**\$1.50**

*There are more Taylor 866/866-A Tubes in use than any other brand.*

Taylor 866-A uses the famous Taylor multi-strand filament which has twice the usual emitting surface. The ceramic insulator between the plate cap and the glass gives increased voltage breakdown protection.

### GENERAL CHARACTERISTICS

Filament Volts.....2.5  
Filament Current, amps.....5.0

### Overall Dimensions

Maximum Height, inches.....6 1/4  
Maximum Diameter, inches.....2 3/4

### UX 4 Prong Base

Max. Peak Inverse Voltage  
Condensed Mercury Temperature 20° to 60° C, volts.....10,000  
Condensed Mercury Temperature 20° to 70° C, volts.....5,000  
Max. Peak Plate Current, amps.....1.0  
Max. Average Plate Current, amps.....0.25

### TYPICAL CIRCUIT—MAXIMUM CONDITIONS

	R.M.S. Input Volts	Max. D.C. Output Volts	Amps.
Single phase full wave (2 tubes).....	3530	3180	0.5
Single phase bridge (4 tubes).....	7060	6360	0.5
Three phase half wave (3 tubes).....	4080	4780	0.75
Three phase parallel double Y (6 tubes) 4080	4080	4780	1.5
Three phase full wave (6 tubes).....	4080	9560	0.75

Figure No.	Transformer Volts E	DC Output Volts at Input to Filter	DC Output Current in Amperes
1	.7 x Inv. Pk. Vtg.	.45 x E	.33 x Pk. Plate
2	.35 x Inv. Pk. Vtg.	.9 x E	.66 x Pk. Plate
3	.35 x Inv. Pk. Vtg.	.9 x E	1.32 x Pk. Plate
4	.7 x Inv. Pk. Vtg.	.9 x E	.66 x Pk. Plate
5	.43 x Inv. Pk. Vtg.	1.12 x E	.83 x Pk. Plate
6	.54 x Inv. Pk. Vtg.	2.25 x E	1.0 x Pk. Plate

**Special Note**  
In transit mercury in tube splatters over filament—therefore when first placing this tube into operation filament should be lighted for fully 15 minutes to allow mercury to condense to bottom of bulb.

### STANDARD RECTIFIER CIRCUITS

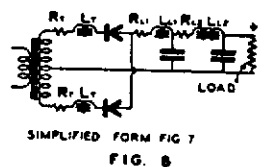
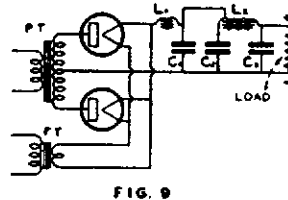
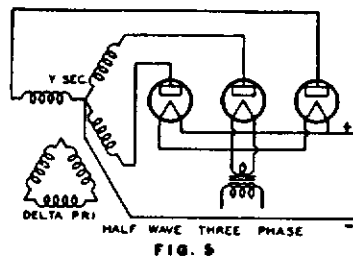
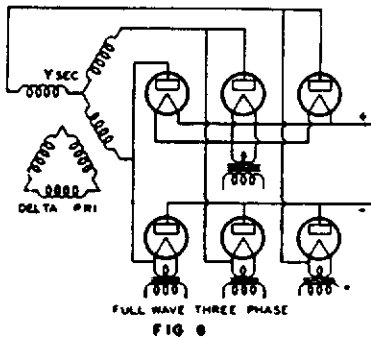
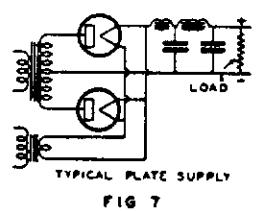
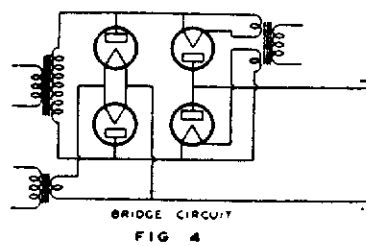
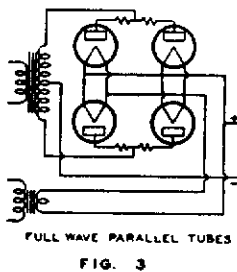
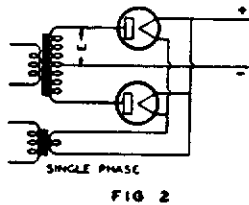
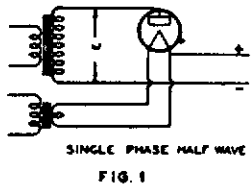

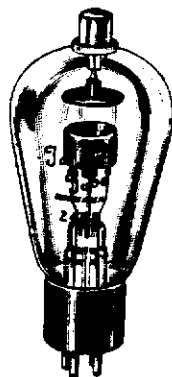

**249-B**  
**NEW! . . . BETTER!**  
**HALF-WAVE**  
**MERCURY VAPOR**  
**RECTIFIER TUBE**  
*New Low Price!*  
**\$5.00**

This new Rectifier tube uses a Processed Carbon Anode and shield together with the recognized advantages of Taylor's Multi-strand filament. The ceramic insulator between the plate cap and the glass gives increased voltage breakdown protection. 249-B's are widely used in Commercial Transmitters and during the past year many Taylor 249-B's went into this service with success. The Taylor 249-B is an exact replacement for tubes with the same type number.

**GENERAL CHARACTERISTICS**

Filament Volts.....2.5  
 Filament Current, amps.....7.5

**Overall Dimensions**

Max. Height, inches.....6 7/8  
 Max. Diameter, inches.....2 1/2  
 Nonex Glass

**UX 4 Prong Base**  
 (See Drawing)

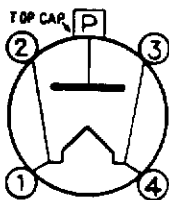

**Max. Peak Inverse Voltage**  
 Condensed Mercury Temperature 20° to 60° C, volts.....10,000  
 Condensed Mercury Temperature 20° to 70° C, volts..... 5,000  
 Max. Peak Plate Current, amps.....1.5  
 Max. Average Plate Current, amps.....0.375

**TYPICAL CIRCUIT—MAXIMUM CONDITIONS**

	R.M.S. Input Volts	Max. D.C. Output Volts	Amps.
Single phase full wave (2 tubes).....	3530	3180	.750
Single phase bridge (4 tubes).....	7060	6360	.750
Three phase half wave (3 tubes).....	4080	4780	1.12
Three phase parallel double Y (6 tubes)	4080	4780	2.25
Three phase full wave (6 tubes).....	4080	9560	1.12

**258-B — \$6.00**

Replaces tube with same type number and has same electrical and physical characteristics as 249-B except base has two 1/4 inch prongs only. Fits W.E. type 138-B socket.

**Special Note**

In transit mercury in tube splatters over filament—therefore when first placing this tube into operation filament should be lighted for fully 15 minutes to allow mercury to condense to bottom of bulb.

**866 JR.**

(2B26)

**HALF-WAVE**  
**MERCURY VAPOR RECTIFIER**

**\$1.00**



The 866 Jrs. fill a real need for intermediate power requirements. They are intended to be used as rectifiers in power supplies of from 600 to 1000 volts D.C. where the receiving type full-wave rectifiers will not stand up and where the power capabilities of the Heavy Duty 866's are not necessary. The smaller size of the 866 Jrs. is another feature that will prove to be of great advantage in the layout of compact power supplies.

Fil. Volts ..... 2.5  
 Fil. Current, Amps..... 2.5  
 Peak Inverse Volts.....5000  
 Peak Plate Current, ma..... 500  
 Av. Plate Current, ma..... 125  
 Tube Volt Drop, Approx..... 15  
 Max. Size 5 1/4 in. x 2 1/4

UX Ceramic Base

**Connect Plate Terminal to Usual Position Standard On All UX Bases**

**866 JR.**

The 866 Jr. uses the multi-strand filament introduced by TAYLOR TUBES. The multi-strand filament construction used in TAYLOR rectifiers has twice the emitting surface of the nickel alloy ribbon type filaments used in ordinary rectifiers.

**BLEEDER RESISTOR SPECIFICATIONS**

Output Voltage	Resistance In Ohms	Actual Dissipated Power In Watts	Recommended Resistor Wattage Rating
500	25,000	10	25
1,000	50,000	20	50
1,500	75,000	25	50
2,200	100,000	40	100
3,000	200,000	45	100

A heavy-duty resistor should be connected across the output of a filter in order to draw some load current at all times. This resistor avoids soaring at no load when swinging choke input is used and also provides a means for discharging the filter condensers when no external vacuum-tube circuit load is connected to the filter. This bleeder resistor should normally draw approximately 10 per cent of the full load current. The above table gives suitable values of bleeder resistors for power supply systems with from 500 to 3000 volts output.

### GENERAL CHARACTERISTICS

Filament Volts .....	10
Filament Current, amps.....	4
Amplification Factor .....	30
Plate Dissipation, watts.....	200

#### Interelectrode Capacities

Grid-Plate, mmf.....	13.5
Grid-Filament, mmf.....	8.5
Plate-Filament, mmf.....	2.1

#### Overall Dimensions

Maximum Length, inches.....	9
Maximum Diameter, inches.....	2 3/4
Standard 50 Watt Base	Nonex Glass

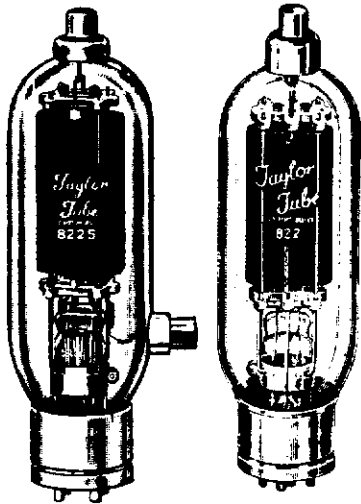

## 822 - 822S

**\$18.50    \$21.50**

### GENERAL PURPOSE TRIODE 200 WATTS PLATE DISSIPATION

The 822 and 822S are unusually efficient and rugged Tubes especially designed for peak performance in all R F services, 822 up to 20 mc; 822S up to 30 mc; and in Class B Audio. These tubes are widely used in Induction Heating and Diathermy apparatus where long-life under abusive conditions demands a tube that "can take it." The 822S is exactly the same as the 822 except that the grid lead comes out through the side of the bulb, thus affording increased safety of operation on higher frequencies.

### CLASS C TELEGRAPHY

#### Maximum Ratings

D. C. Plate Volts .....	2500
D. C. Plate Current, ma.....	300
D. C. Grid Current, ma.....	60
D. C. Grid Volts .....	400
Plate Dissipation, watts.....	200

#### Typical Operating Conditions

D. C. Plate Volts.....	2000	2500
D. C. Plate Current, ma.....	300	300
D. C. Grid Current, ma.....	51	51
D. C. Grid Bias Volts.....	-136	-190
From Grid Leak of, ohms.....	2670	3730
Or { Fixed Supply of, volts.....	-75	-100
From { Plus Grid Leak of, ohms.....	1200	1765
Plate Dissipation, watts.....	140	150
Power Output, watts.....	460	600
Driving Power, watts.....	14	17

### CLASS C TELEPHONY

#### Maximum Ratings

D. C. Plate Volts .....	1000
D. C. Plate Current, ma.....	250
D. C. Grid Current, ma.....	60
D. C. Grid Volts .....	400
Plate Dissipation, watts.....	135

#### Typical Operating Conditions

D. C. Plate Volts .....	1750	2000
D. C. Plate Current, ma.....	250	250
D. C. Grid Current, ma.....	45	43
D. C. Grid Bias Volts.....	151	195
From Grid Leak of, ohms.....	3350	4500
Or { Fixed Supply of, volts.....	-65	-75
From { Plus Grid Leak of, ohms.....	1900	2800
Plate Dissipation, watts.....	92	95
Power Output, watts.....	345	405
Driving Power, watts.....	12.5	13.7

### CLASS B AUDIO

#### Typical Operating Conditions for Two Tubes

D. C. Plate Volts .....	1500	2000	2500	3000
D. C. Plate Current, ma.....	500	500	500	450
D. C. Grid Bias Volts.....	-35	-45	-67.5	-80
Power Output, watts.....	525	720	900	1000
Driving Power, watts.....	7	7.2	7.4	8
Plate to Plate Load, ohms.....	6800	9500	12000	16000
Peak Grid to Grid Volts.....	286	306	351	362

### CLASS B AUDIO DATA

The chart below gives the max. average value as would be indicated on the plate current meter with sine wave input. For the same peak output with voice input the max. average plate current reading will be approximately 50 to 60 per cent of this value.

Supply Voltage ↓	400	500	750	1000	Audio Watts ← Output
3000		32000 230 ma. 2.6	21500 340 ma. 4.6	16000 500 ma. 8.0	← Plate to Plate load ← Max. Av. Ip. ← Watts drive
2500		22000 280 ma. 3.5	14500 410 ma. 6.0	10500 560 ma. 8.5	← Plate to Plate load ← Max. Av. Ip. ← Watts drive
2000	16800 285 ma. 3.25	13000 360 ma. 4.8	8800 525 ma. 7.4		← Plate to Plate load ← Max. Av. Ip. ← Watts drive
1500	9000 390 ma. 4.4	7100 500 ma. 6.7			← Plate to Plate load ← Max. Av. Ip. ← Watts drive

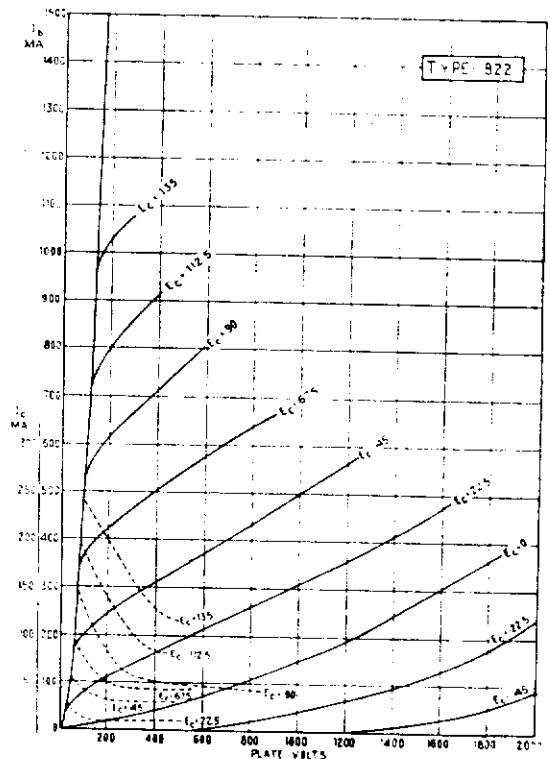



# Taylor



# Tubes

## T-40

**GENERAL PURPOSE TRIODE  
40 WATTS PLATE DISSIPATION**

*The Wonder Tubes*

### \$3.50

**260 WATTS Safety Factor**

In six years over 200,000 T-40's and TZ-40's were put into operation in Amateur and Commercial Transmitters in nearly every country in the world. They are widely used by the British government. These Wonder Tubes are the most popular medium power Transmitting Tubes ever developed and they unquestionably set a new and higher standard of "Watts per Dollar" in this field. Prior to the advent of the T-40 and TZ-40, the only comparative tube sold for \$10.00, which is further proof that Taylor Tubes is solely responsible for today's outstanding values in Transmitting Tubes.

T-40's and TZ40's offer you Processed Carbon Arcodes together with complete Molybdenum grids, making possible the Safest Tube in their class in their ability to withstand serious temporary overloads. The scientifically designed Thoriated Tungsten filaments insure long-life and maximum emission.

### TECHNICAL DATA

While the rated plate dissipation of the T-40 and TZ-40 is 40 watts no color shows on the plate until the dissipation amounts to approximately 60 watts and it takes about 90 watts to cause a red spot in the center of the plate. In this catalog it will be noticed that the TZ-40 has been recommended as an R.F. Amplifier. The reason is that due to the Zero Bias characteristics the plate current will drop to a low value when excitation ceases such as in keying of a preceding stage. This eliminates the necessity of a fixed source of bias as would be required by a T-40 under similar conditions. Comparing the T-40 and TZ-40 we note that the T-40 is easier to drive than the TZ-40. However, in most cases the small additional driving power required by the TZ-40 is less objectionable than the fixed source of bias that must be used with the T-40.



### GENERAL CHARACTERISTICS

Filament Volts .....	7.5
Filament Current, amps.....	3.0
Amplification Factor .....	25
Plate Dissipation, watts.....	40

### Interelectrode Capacities

Grid-Plate, mmf. ....	5.2
Grid-Filament, mmf. ....	4.9
Plate-Filament, mmf. ....	1.0

### Overall Dimensions

Maximum Length, inches.....	6 1/4
Maximum Diameter, inches.....	2 1/8

**Alsimag** **UX 4 Prong Base**

### CLASS C TELEGRAPHY

#### Maximum Ratings

	C.C.S.	I.C.A.S.
D. C. Plate Volts.....	1250	1500
D. C. Plate Current, ma.....	125	150
D. C. Grid Current, ma.....	40	40
D. C. Grid Volts .....	250	250
Plate Dissipation, watts.....	40	40*

#### Typical Operating Conditions

D. C. Plate Volts.....	1250	1500
D. C. Plate Current, ma.....	125	150
D. C. Grid Current, ma.....	25	28
D. C. Grid Bias Volts.....	-110	-140
From Grid Leak of, ohms.....	4400	5000
Or { Fixed Supply of, volts.....	-60	-75
From { Plus Grid Leak of, ohms.....	2000	2300
Plate Dissipation, watts.....	40	67*
Power Output, watts.....	116	158
Driving Power, watts.....	6.5	9

\* It is permissible to allow the plate dissipation to approach twice the normal rating in telegraph service where key down condition exists approximately 50 per cent of the time.

### CLASS C TELEPHONY

#### Maximum Ratings

	C.C.S.	I.C.A.S.
D. C. Plate Volts.....	1000	1250
D. C. Plate Current, ma.....	115	125
D. C. Grid Current, ma.....	40	40
D. C. Grid Volts.....	250	250
Plate Dissipation, watts.....	30	40*

#### Typical Operating Conditions

D. C. Plate Volts.....	1000	1250
D. C. Plate Current, ma.....	100	115
D. C. Grid Current, ma.....	18	20
D. C. Grid Bias Volts.....	-100	-115
From Grid Leak of, ohms.....	5600	5750
Or { Fixed Supply of, volts.....	50	60
From { Plus Grid Leak of, ohms.....	2800	2750
Plate Dissipation, watts.....	29	40*
Power Output, watts.....	71	104
Driving Power, watts.....	4.2	5.25

\* The intermittent nature of voice modulation in amateur telephone transmission permits the use of the maximum plate dissipation ratings.

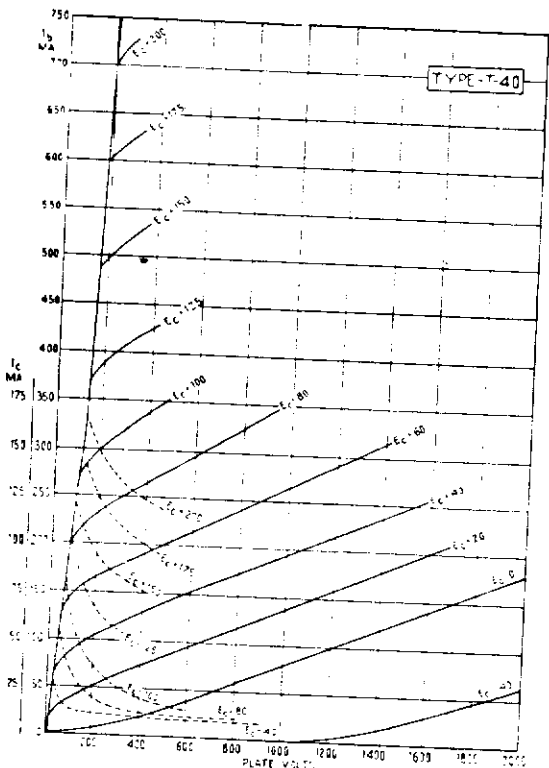

# Taylor

**CUSTOM  
BUILT**

# Tubes

## TZ-40

**ZERO BIAS TRIODE  
40 WATTS PLATE DISSIPATION  
The Wonder Tubes**

**\$3.50**

**DELIVER 250 WATTS CLASS B AUDIO  
OUTPUT  
THE IDEAL DOUBLER TUBE**

### CLASS B AUDIO DATA

In the chart below, the current value is the maximum average value as would be indicated on the plate current meter with sine wave input. For the same peak output with voice input the maximum average plate current as indicated on meter will be approximately 50 to 60 per cent of this value.

Audio Watts Output ↓	750	1000	1250	1500	Supply Voltage ←
100	6000 230 ma. 4.0	15500 145 ma. 2.0			←Plate to Plate load ←Max. Av. Ip. ←Watts drive
150		8800 240 ma. 4.4	16000 175 ma. 2.75W		←Plate to Plate load ←Max. Av. Ip. ←Watts drive
175		7350 280 ma. 5.5	14000 200 ma. 3.4	20000 170 2.75	←Plate to Plate load ←Max. Av. Ip. ←Watts drive
225			10000 280 ma. 6.0	16000 215 3.85	←Plate to Plate load ←Max. Av. Ip. ←Watts drive
250				12000 250 ma. 6.0	←Plate to Plate load ←Max. Av. Ip. ←Watts drive

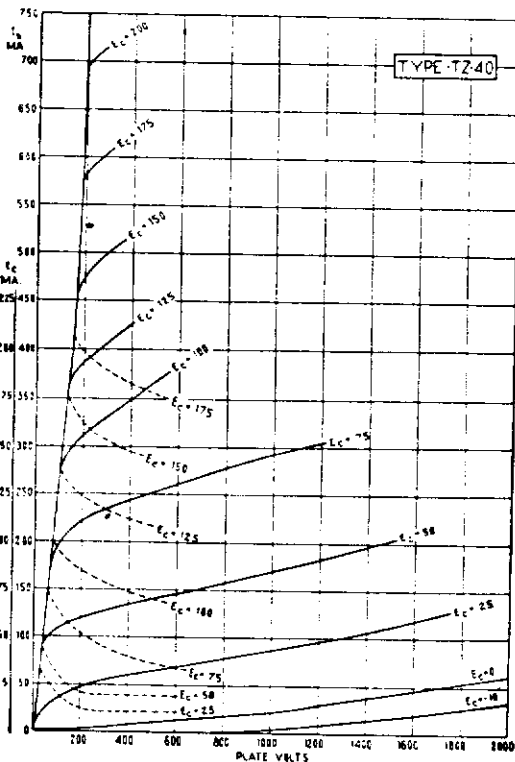

### GENERAL CHARACTERISTICS

Filament Volts	7.5
Filament Current, amps	3.0
Amplification Factor	62
Plate Dissipation, watts	40

### Interelectrode Capacities

Grid-Plate, mmf.	5.0
Grid-Filament, mmf.	4.8
Plate-Filament, mmf.	0.8

### Overall Dimensions

Maximum Length, inches	6 1/4
Maximum Diameter, inches	2 3/4
Alsimag	UX 4 Prong Base

### CLASS C TELEGRAPHY, Maximum Ratings

	C.C.S.	I.C.A.S.
D. C. Plate Volts	1250	1500
D. C. Plate Current, ma	125	150
D. C. Grid Current, ma	45	45
D. C. Grid Volts	250	250
Plate Dissipation, watts	40	40*

### Typical Operating Conditions

D. C. Plate Volts	1250	1500
D. C. Plate Current, ma	125	150
D. C. Grid Current, ma	31	38
D. C. Grid Bias Volts	-90	-90
From Grid Leak of, ohms	2900	2370
Plate Dissipation, watts	40	60*
Power Output, watts	116	165
Driving Power, watts	7.25	10

\* It is permissible to allow the plate dissipation to approach twice the normal rating in telegraph service where key down condition exists approximately 50 per cent of the time.

### CLASS C TELEPHONY, Maximum Ratings

	C.C.S.	I.C.A.S.
D. C. Plate Volts	1000	1250
D. C. Plate Current, ma	115	125
D. C. Grid Current, ma	45	45
D. C. Grid Volts	250	250
Plate Dissipation, watts	30	40*

### Typical Operating Conditions

D. C. Plate Volts	1000	1250
D. C. Plate Current, ma	100	125
D. C. Grid Current, ma	26	30
D. C. Grid Bias Volts	-65	-100
From Grid Leak of, ohms	2500	3300
Plate Dissipation, watts	27	40*
Power Output, watts	73	116
Driving Power, watts	4.6	7.5

\* The intermittent nature of voice modulation in amateur transmission permits the use of the maximum plate dissipation rating.

### CLASS B AUDIO

#### Typical Operation Conditions for Two Tubes

	C.C.S.		I.C.A.S.	
D. C. Plate Volts	1250	1000	1500	1250
D. C. Plate Current, ma	240	200	250	280
D. C. Grid Bias Volts	-4.5	0	-9	-4.5
Power Output, watts	200	130	250	225*
Driving Power, watts	4.5	2.8	6	6
Plate to Plate Load, ohms	11000	11000	12000	10000
Peak Grid to Grid Volts	242	200	265	269

\* The intermittent nature and low average power in a voice wave permits use of higher peak power output without overloading the tubes. Power outputs listed are for sine wave voltage and are intended for use in calculating modulating capabilities. Actually the power output is much less with voice input.

# Taylor

**CUSTOM  
BUILT**

# Tubes

### R-F POWER AMPLIFIER AND OSCILLATOR, CLASS C

	C.C.S.	I.C.A.S.
Plate Volts, D. C., max.....	2000	2250
Plate Current, D. C., milliamperes, max....	250	275
Plate Input, watts, max.....	500	620
Plate Dissipation, watts, max.....	125	150
Plate Volts & Input Max. % for 30 MC, %	100	100
Plate Volts & Input Max. % for 60 MC, %	70	70
Plate Volts & Input Max. % for 100 MC, %	50	50
Grid Volts, D. C., max.....	-500	-500
Grid Current, D. C., milliamperes, max....	70	70

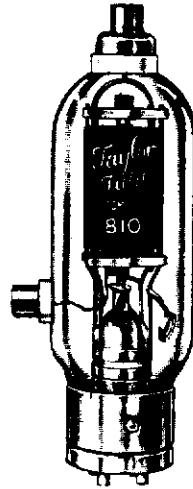

## 810

**AMPLIFIER AND OSCILLATOR TRIODE**

**125 WATTS PLATE DISSIPATION**

## \$13.50

The Taylor 810 is a general purpose Triode rated for full input on frequencies up to 30 MC, and at 50% up to 100 MC. The 810 design incorporates features that insure long, safe operation in Transmitters, Diathermy equipment and Induction Heating Apparatus.

### TYPICAL OPERATION

Plate Volts, D. C. ....	1500	2000	2250
Plate Current, D. C., milliamperes.....	250	250	275
Grid Volts, D. C. ....	-120	-160	-160
From Cathode Resistor, ohms.....	415	550	510
From Grid Resistor, ohms.....	3000	4000	4000
Grid Volts, Peak R-F.....	280	330	330
Grid Current, D. C., ma.....	40	40	40
Driving Power, watts.....	10	12	12
Power Output, watts.....	275	375	475

### A-F POWER AMPLIFIER AND MODULATOR, CLASS B

#### TYPICAL OPERATION

Unless Otherwise Specified, Values Are for 2 Tubes

Plate Volts, D. C. ....	1500	2000	2250
Plate Current, Zero-Sig. D. C., ma.....	80	60	70
Plate Current, Max-Sig. D. C., ma.....	500	420	450
Grid Volts, D. C. ....	-30	-50	-60
Grid-to-Grid Volts, Peak A-F.....	345	345	880
Load Resistor, ohms (per tube).....	1650	2750	2900
Effective Load Resistor, ohms (pl-pl).....	6600	11000	11600
Max-Sig. Drive, watts.....	12	10	13
Max-Sig. Power Output, watts.....	510	590	725

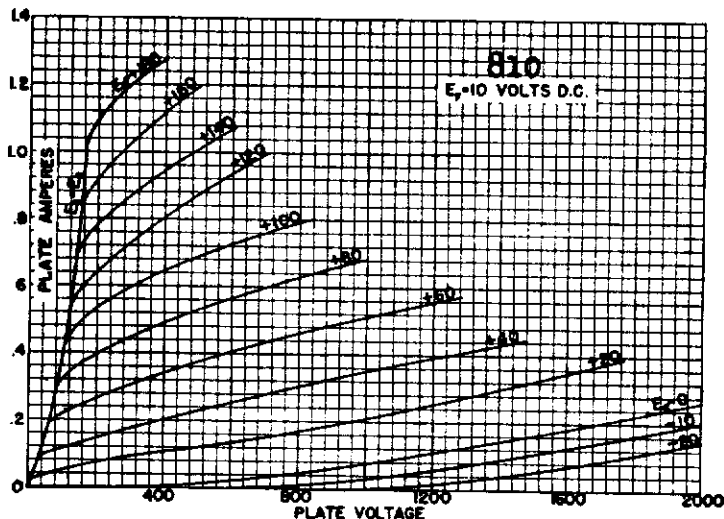

### GENERAL CHARACTERISTICS

Filament Voltage, volts.....	10.0
Filament Current, amps. ....	4.5
Amplification Factor .....	36
Capacitance, Grid-Plate, uuf.....	4.8
Capacitance, Grid-Filament, uuf.....	8.7
Capacitance, Plate-Filament, uuf.....	12

### PLATE-MODULATED R-F POWER AMPLIFIER, CLASS C

	C.C.S.	I.C.A.S.
Plate Volts, D. C., max.....	1600	1800
Plate Current, D. C., milliamperes, max.....	210	250
Plate Input, watts, max.....	335	450
Plate Dissipation, watts, max.....	85	125
Plate Volts and Input Max. % for 30 MC, %.....	100	100
Plate Volts and Input Max. % for 60 MC, %.....	70	70
Plate Volts and Input Max. % for 100 MC, %.....	50	50
Grid Volts, D. C., max.....	-500	-500
Grid Current, D. C., milliamperes, max.....	70	70

### TYPICAL OPERATION

Plate Volts, D. C. ....	1250	1600	1800
Plate Current, D. C., milliamperes.....	210	210	250
Grid Volts, D. C. ....	-200	-200	-200
From Grid Resistor, ohms.....	4000	4000	4000
Grid Volts, Peak R-F.....	370	370	370
Grid Current, D. C., milliamperes.....	50	50	50
Driving Power, watts.....	17	17	17
Power Output, watts.....	180	250	335

# Taylor

**CUSTOM  
BUILT**

# Tubes

## T-125

**WITH ACCELERATING FINs  
125 WATTS PLATE DISSIPATION  
TRIODE**

### \$13.50

**TAYLOR T-124**

*Identical specifications and characteristics as the T-125 except the amp. factor is 48.*

The T125 is the tube amateurs demanded to fill the gap between the T55 and T200. It's a mansized tube at low cost and it features a new TAYLOR invention (patent applied for) making possible high efficiency at low plate voltages and with low inter-electrode capacities. Rated conservatively, one tube will handle a full 500 watts input at the maximum ratings of 2000 volts, 250MA. The interelectrode capacities are low, making possible efficient operation on even the highest amateur frequencies—but the use of accelerating fins increases the inherent efficiency of the tube, making it far more efficient than others with comparative interelectrode capacities. These fins projecting inward toward the grid and filament effectively produce the very desirable characteristics of higher C tubes without greatly increasing the capacities. Thus this tube is truly unique in that it possesses the advantages of a low C tube together with the advantages of a higher C tube—without the disadvantages of either. It is truly a remarkable tube and is a revolutionary step forward in tube design.

At the rated plate dissipation of 125 watts the carbon plate shows no color but the accelerating fins operate at a bright orange color. If the type of operation or input are not such as to result in excessive dissipation, color showing on the plate may be taken as a definite indication that the circuit is less efficient than it should be.

For some time there has been a need for a high frequency tube to replace tubes of the 203A type with the absolute minimum of changes in the transmitter. The T125 fills the needs in a most satisfactory manner. Because of the exclusive TAYLOR Accelerating Fins construction, efficiencies on the order of those obtained with 03A's are possible at the same plate voltages and with the same low grid drive requirements. In addition the plate dissipation is greater than that of an 03A and the plate current rating greater making it possible to increase the power at the same Plate voltage as well as gaining the advantages of low C tube operation at the higher frequencies. In order to replace an 03A type of tube with the T125 it will be necessary only to change the grid and plate connections and to re-neutralize. If the minimum capacity of the neutralizing condenser is too high, plates may be removed. No circuit or bias changes are necessary because the Mu of the T125 is the same as that of an 03A.

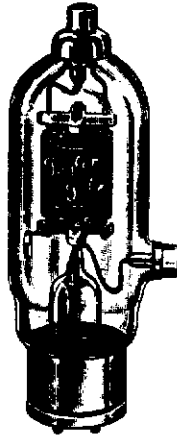

### GENERAL CHARACTERISTICS

Filament Volts .....	10
Filament Current, amps .....	4.5
Plate Dissipation, watts .....	125
Amp. Factor .....	25

### Overall Dimensions

Max. Length, Inches .....	8 1/4
Max. Diameter, Inches .....	3

### Interelectrode Capacities

Grid-Plate, mmf .....	6.0
Grid-Filament, mmf .....	6.3
Plate-Filament, mmf .....	2.6
<b>Nonex Glass</b> .....	<b>50 watt base</b>

### CLASS C TELEGRAPHY

#### Maximum Ratings

	C.C.S.	I.C.A.S.
D. C. Plate Volts .....	2000	2500
D. C. Plate Current .....	250	250
D. C. Grid Current .....	70	70
D. C. Grid Volts .....	-500	-500
Plate Dissipation, watts .....	125	125#

#### Typical Operating Conditions

	C.C.S.		I.C.A.S.	
D. C. Plate Volts .....	1500	2000	2000	2500
D. C. Plate Current .....	250	250	250	250
D. C. Grid Current .....	35	34	34	35
D. C. Grid Bias Volts .....	-125	-150	-150	-200
From Grid leak of, ohms .....	3600	4300	4300	5700
Plate Dissipation, watts .....	99	118	118	125#
Driving Power, watts .....	10	10	10	12.5
Peak AC Grid Volts .....	315	335	335	400

# It is permissible to allow the plate dissipation to approach twice this value in telegraph service where key down condition exists approximately half the time.

### CLASS C TELEPHONY

#### Maximum Ratings

	C.C.S.	I.C.A.S.
D. C. Plate Volts .....	1750	2000
D. C. Plate Current .....	210	250
D. C. Grid Current .....	70	70
D. C. Grid Volts .....	-500	-500
Plate Dissipation, watts .....	85	125

#### Typical Operation Conditions

	C.C.S.		I.C.A.S.	
D. C. Plate Volts .....	1500	1750	1500	2000
D. C. Plate Current .....	200	200	250	250
D. C. Grid Current .....	30	30	35	35
D. C. Grid Bias Volts .....	-150	-175	-165	-165
From Grid leak of, ohms .....	5000	5800	4700	4700
Or { Fixed Supply of, volts .....	-60	-70	-60	-80
From { Plus Grid Leak of, ohms .....	3000	3500	3000	2500
Plate Dissipation, watts .....	70	78	94	120*
Driving Power, watts .....	8	9.5	11	12
Peak AC Grid Volts .....	315	345	360	380

\* The intermittent nature of voice modulation permits the use of the full plate dissipation rating of the tube.

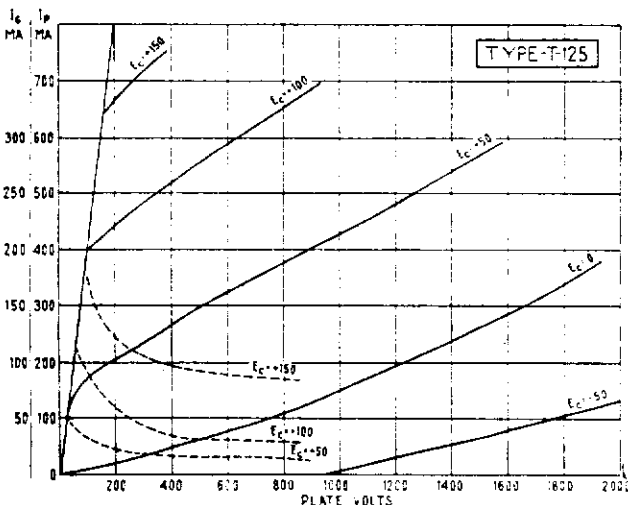

# Taylor

**CUSTOM  
BUILT**

# Tubes

## T-200

200 WATTS PLATE DISSIPATION  
TRIODE

**\$21.50**

57.5 WATT FILAMENT

The T-200 has often been called "The Amateur's Power House Tube." A pair of these tubes push-pull will loaf along at 1 kw input on any frequency from 30 to 1.7MC. This tube uses the efficient flat form of construction and the inter-electrode capacities represent the best possible combination of inter-electrode capacities and other characteristics for best efficiency at moderate plate voltages with minimum grid drive requirements. The inter-electrode capacities are low enough for ease of neutralization yet are not so low that the characteristics of the tube are adversely affected. Many amateurs prefer a tube that will deliver good efficiency at high current and relatively low plate voltage and the T-200 is the answer. A plate modulated input of 450 watts with only 18 watts drive at 1500 volts is just what many have been thinking about and we recommend the T-200 highly under these conditions. A large percentage of high-powered transmitters on 75 and 160 meters use T-200's with great success.

The T200 is widely used in Diathermy equipment. This type of service is particularly hard on Tubes and the general acceptance of the T200 by many leading manufacturers of Diathermy equipment is convincing proof of the T200's rugged construction and conservative rating. Do not confuse the T200 with smaller tubes bearing the same type number.

### T-200 POPULARITY

*Some of the leading Diathermy and Induction Heating apparatus manufacturers use the Taylor T-200. Long, trouble-free operation is the factor that makes the Taylor T-200 the standard of comparison in its class.*

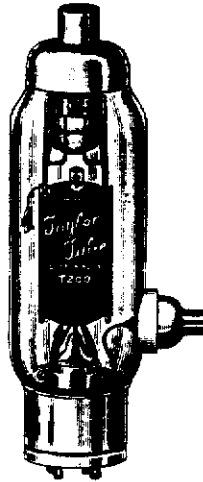

### GENERAL CHARACTERISTICS

Filament Volts .....	10.0
Filament Current, amps .....	5.75
Amplification Factor .....	17
Plate Dissipation, watts .....	200

### Interelectrode Capacities

Grid-Plate, mmf. ....	7.9
Grid-Filament, mmf. ....	9.5
Plate-Filament, mmf. ....	1.6

### Overall Dimensions

Maximum Diameter, inches .....	9 1/2
Maximum Length, inches .....	3 3/4

50 Watt Base

Nonex Glass

### CLASS C TELEGRAPHY

#### Maximum Ratings

D. C. Plate Volts .....	2500
D. C. Plate Current, ma .....	350
D. C. Grid Current, ma .....	60
D. C. Grid Volts .....	400
Plate Dissipation, watts .....	200

#### Typical Operating Conditions

D. C. Plate Volts .....	2000	2500
D. C. Current, ma .....	350	300
D. C. Grid Current, ma .....	56	48
D. C. Grid Bias Volts .....	-205	-265
From Grid Leak of, ohms .....	3640	5500
Or { Fixed Supply of, volts .....	120	150
From { Plus Grid Leak of, ohms .....	1500	2400
Plate Dissipation, watts .....	178	180
Power Output, watts .....	522	590
Driving Power, watts .....	21.7	20

### CLASS C TELEPHONY

#### Maximum Ratings

D. C. Plate Volts .....	2000
D. C. Plate Current, ma .....	300
D. C. Grid Current, ma .....	60
D. C. Grid Volts .....	400
Plate Dissipation, watts .....	140

#### Typical Operating Conditions

D. C. Plate Volts .....	1500	2000
D. C. Plate Current, ma .....	300	250
D. C. Grid Current, ma .....	50	41
D. C. Grid Bias Volts .....	-205	-220
From Grid Leak of, ohms .....	4100	5400
Or { Fixed Supply of, volts .....	100	125
From { Plus Grid Leak of, ohms .....	2100	2300
Plate Dissipation, watts .....	117	110
Power Output, watts .....	333	390
Driving Power, watts .....	18.7	15

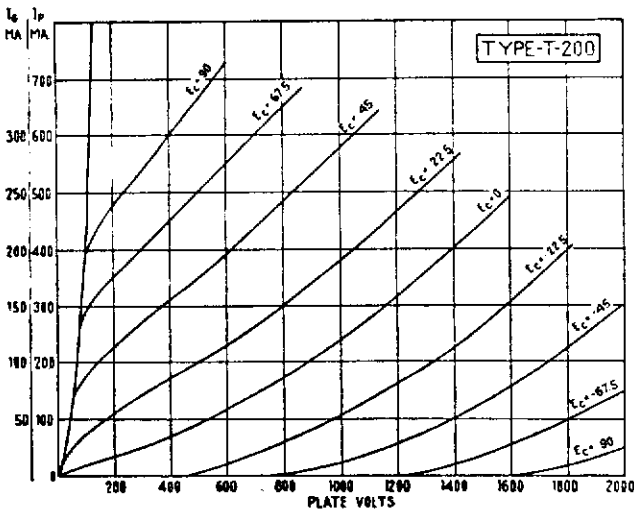

# Taylor

**CUSTOM  
BUILT**

# Tubes

## 805

**125 WATTS PLATE DISSIPATION  
CARBON ANODE**

**\$11.00**

**ZERO BIAS  
UP TO 510 WATTS  
CLASS B AUDIO OUTPUT**

The 805 is a high mu zero bias tube of popular type incorporating the use of the famous heat tested Speer processed carbon anodes together with the Taylor Floating anode type of construction. The plate lead is brought out the top greatly minimizing the chances of voltage breakdowns.

The no-signal or static plate current is about 55MA per tube at 1250 volts (zero bias) and about 30MA per tube at 1500 volts when 15 bias volts are added. Because the 805 is a zero bias tube, or practically so, grid current flows during nearly all of the input cycle. Due to this, the input transformer design requirements are less involved and excellent frequency response with minimum distortion is easily realized. The maximum average grid driving power is approximately 8 watts. Low impedance triodes such as 2A3's or 6A3's should be used in the driver stage.



### GENERAL CHARACTERISTICS

Filament Volts .....	10
Filament Current, amps.....	3.25
Amplification Factor, approx.....	45
Plate Dissipation, watts.....	125

### Interelectrode Capacities

Grid-plate, mmf. ....	6.3
Grid-filament, mmf. ....	8.4
Plate-filament, mmf. ....	7.0

### Overall Dimensions

Maximum length, inches.....	8 1/2
Maximum diameter, inches.....	2 1/8
<b>50 Watt Base</b>	<b>Nonex Glass</b>

### CLASS C TELEGRAPHY Maximum Ratings

D. C. Plate Volts.....	1750
D. C. Plate Current, ma.....	210
D. C. Grid Current, ma.....	70
D. C. Grid Volts.....	500
Plate Dissipation, watts.....	125

### Typical Operating Conditions

D. C. Plate Volts.....	1000	1500	1750
D. C. Plate Current, ma.....	200	200	200
D. C. Grid Current, ma.....	45	45	44
D. C. Grid Bias Volts.....	-75	-85	-90
From grid leak of, ohms.....	1650	1880	2000
Or { Fixed Supply of, volts.....	-30	-50	-60
From { Plus Grid Leak of, ohms.....	1000	780	700
Plate Dissipation, watts.....	56	72	80
Power Output, watts.....	144	228	270
Driving Power, watts.....	8.7	9	9.2

### CLASS C TELEPHONY Maximum Ratings

D. C. Plate Volts.....	1500
D. C. Plate Current, ma.....	175
D. C. Grid Current, ma.....	70
D. C. Grid Volts.....	500
Plate Dissipation, watts.....	85

### Typical Operating Conditions

D. C. Plate Volts.....	1000	1500
D. C. Plate Current, ma.....	175	175
D. C. Grid Current, ma.....	45	40
D. C. Grid Bias Volts.....	-100	-140
From grid leak of, ohms.....	2200	3500
Or { Fixed Supply of, volts.....	-30	-50
From { Plus Grid Leak of, ohms.....	1500	2250
Plate Dissipation, watts.....	50	55
Power Output, watts.....	125	208
Driving Power, watts.....	10.0	10.5

### CLASS B AUDIO

#### Typical Operating Conditions For Two Tubes

D. C. Plate Volts.....	1250	1500	1750
D. C. Plate Current, ma.....	400	420	420
D. C. Grid Bias Volts.....	0	-15	-22.5
Power Output, watts.....	325	400	510
Driving Power, watts.....	8.5	9.5	10
Plate to Plate load, ohms.....	6700	7850	9350
Peak Grid to Grid Volts.....	288	306	320

### 805 CLASS B AUDIO DATA

Supply Voltage ↓	275	325	400	450	←Audio Watts Output	
1750		270MA 15,000 4.5	330MA 12,000 6.0	390MA 10,000 9.0	←Max. Av. Ip ←Plate to Plate Load ←Watts Drive	
	1500	276MA 12,000 5.0	330MA 10,000 7.0	420MA 8,000 9.5	420MA 9,350 10.0	←Max. Av. Ip ←Plate to Plate Load ←Watts Drive
		1250	335MA 8,000 6.25	395MA 6,800 8.5	←Max. Av. Ip ←Plate to Plate Load ←Watts Drive	

The chart above gives proper Class B Audio operating conditions for various outputs at different plate voltages. The most important value is the reflected load impedance which is given for the entire primary or plate to plate. The current value is the maximum average value as would be indicated on the plate current meter with sine wave input. For the same peak output with voice input the maximum average plate current will be approximately 50% to 60% of this value.

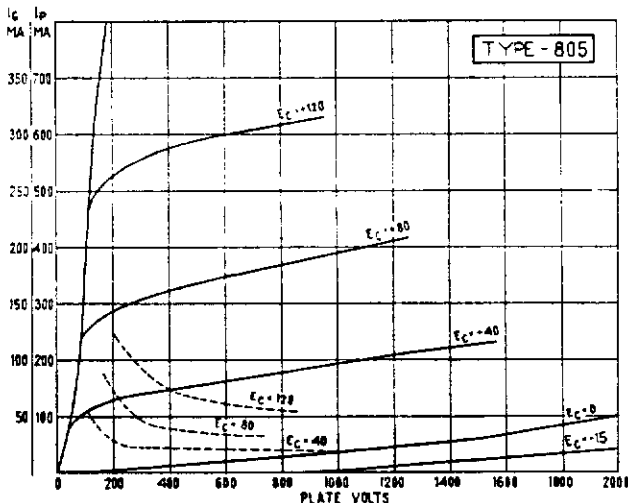

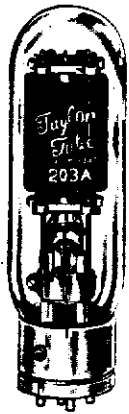

## 203-A

100 WATTS PLATE DISSIPATION  
OSCILLATOR AND AMPLIFIER  
TRIODE

**\$10.00**

**GENERAL CHARACTERISTICS**

Fil. Volts .....	10
Fil. Current, amps.....	3.25
Amp. Factor .....	25
<b>Nonex Glass</b> .....	<b>50 Watt Base</b>

**OVERALL DIMENSIONS**

Maximum Length, inches.....	7½
Maximum Diameter, inches.....	2⅞

**INTERELECTRODE CAPACITIES**

Plate to Grid, mmf.....	14
Grid to Filament, mmf.....	8
Plate to Filament, mmf.....	7

**R-F POWER AMPLIFIER AND OSCILLATOR—CLASS C  
MAXIMUM RATINGS**

D. C. Plate Volts .....	1250
D. C. Plate Current, ma.....	175
D. C. Grid Current, ma.....	60
D. C. Grid Volts .....	—400

**TYPICAL OPERATING CONDITIONS**

D. C. Plate Volts .....	1250
D. C. Plate Current, ma.....	175
D. C. Grid Current, ma.....	25
D. C. Grid Bias Volts.....	—125
From Grid Resistor, ohms.....	5000
From Cathode Resistor, ohms.....	725
Driving Power, watts.....	7
Power Output, watts.....	150
Full Input to 15 mc.....	75% to 30 mc.

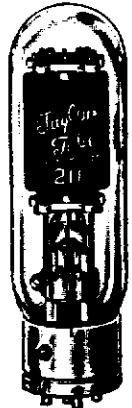
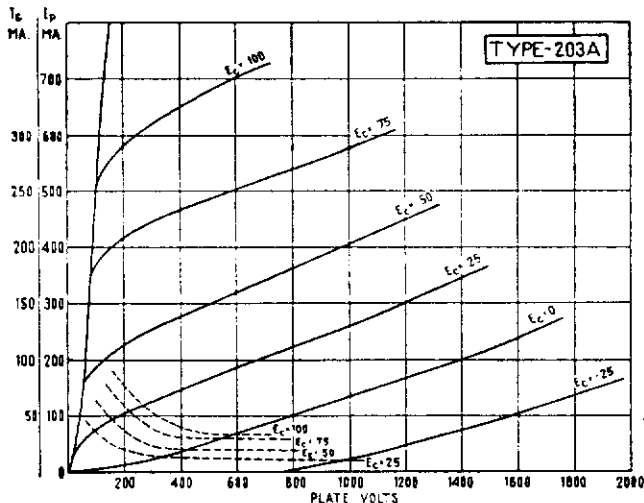

## 211-211-D

100 WATTS PLATE DISSIPATION  
OSCILLATOR AND AMPLIFIER  
TRIODE

**\$10.00**

**GENERAL CHARACTERISTICS**

Fil. Volts .....	10
Fil. Current, amps.....	3.25
Amp. Factor .....	25
<b>Nonex Glass</b> .....	<b>50 Watt Base</b>

**OVERALL DIMENSIONS**

Maximum Length, inches.....	7½
Maximum Diameter, inches.....	2⅞

**INTERELECTRODE CAPACITIES**

Plate to Grid, mmf.....	14
Grid to Filament, mmf.....	7
Plate to Filament, mmf.....	6

**R-F POWER AMPLIFIER AND OSCILLATOR—CLASS C  
MAXIMUM RATINGS**

D. C. Plate Volts .....	1250
D. C. Plate Current, ma.....	175
D. C. Grid Current, ma.....	60
D. C. Grid Volts .....	—400

**TYPICAL OPERATING CONDITIONS**

D. C. Plate Volts .....	1250
D. C. Plate Current, ma.....	175
D. C. Grid Current, ma.....	35
D. C. Grid Bias Volts .....	—260
From Grid Resistor, ohms.....	7500
Driving Power, watts.....	7
Power Output, watts.....	150
Full Input to 15 mc.....	75% to 30 mc.

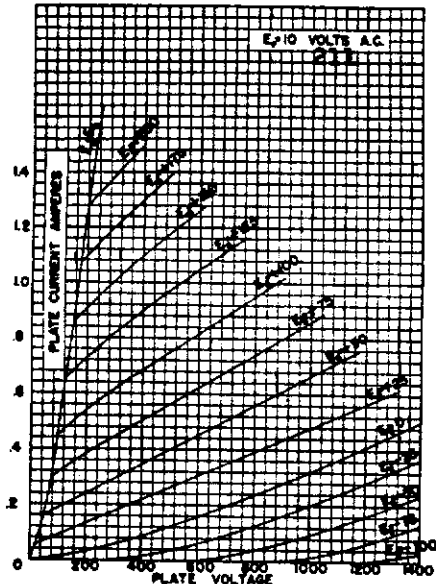

# Taylor

**CUSTOM  
BUILT**

# Tubes



## 211-C

EXACT REPLACEMENT FOR W.E.261-A

100 WATTS PLATE DISSIPATION

CARBON ANODE

LOW INTERELECTRODE CAPACITIES

### \$12.50

#### GENERAL CHARACTERISTICS

Type 211-C

Filament Voltage, volts.....	10
Filament Current, amps.....	3.25
Plate Resistance, ohms.....	2800
Mutual Conductance, uMhos.....	4500
Amplification Factor.....	12.5
Nonex Glass	50 Watt Base

#### OVERALL DIMENSIONS

Maximum Length, inches.....	7½
Maximum Diameter, inches.....	2½

#### INTERELECTRODE CAPACITIES

Plate to Grid, mmf.....	9
Grid to Filament, mmf.....	6
Plate to Filament.....	6.5

#### R F POWER AMP. AND OSC-CLASS C MAXIMUM RATINGS

D. C. Plate Volts .....	1250
D. C. Plate Current, ma.....	175
D. C. Grid Current, ma.....	60
D. C. Grid Volts .....	-400

#### TYPICAL OPERATING CONDITIONS

D. C. Plate Volts .....	1250
D. C. Plate Current, ma.....	175
D. C. Grid Current, ma.....	38
D. C. Grid Bias, volts .....	-260
From Grid Resistor, ohms.....	7500
Driving Power, watts.....	8
Power Output, watts.....	150
Full input to 20 mc.....	80% to 30 mc

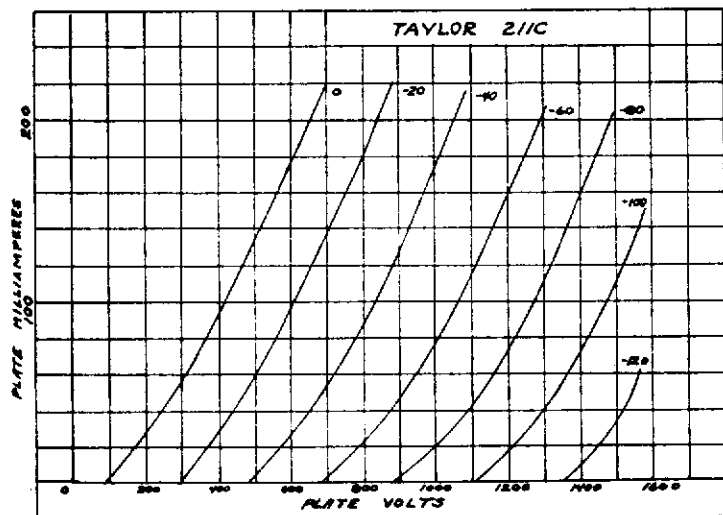

## 845

EXACT REPLACEMENT FOR W.E.284-A

100 WATTS PLATE DISSIPATION

### \$10.00

CLASS "A" AUDIO TUBE

#### GENERAL CHARACTERISTICS TYPE 845

Filament Voltage.....	10
Filament Current, amps.....	3.25
Mutual Conductance, uMhos.....	3000
Amplification Factor.....	5
Maximum Length.....	7½
Maximum Diameter.....	2½
Plate to Grid, mmf.....	14
Grid to Filament, mmf.....	6.5
Plate to Filament.....	6
Nonex Glass	50 Watt Base

#### CLASS A-A-F POWER AMP. AND MOD., TYPICAL OPERATING CONDITIONS

Plate Volts, D-C .....	750	1000	1250
Plate Current, D-C, milliamperes.....	95	90	80
Plate Resistance, ohms .....	1700	1700	1700
Grid Volts, D-C .....	-98	-145	-195
From Cathode Resistor of (ohms).....	1030	1610	2435
Grid Swing, Peak A-F, volts.....	93	140	190
Transconductance, umhos .....	3100	3100	3100
Load Resistance, ohms .....	3400	6000	11000
Undistorted Power Output, watts.....	15	24	30

#### A-F POWER AMP. AND MOD., CLASS AB

Unless Otherwise Specified, Values Are for 2 Tubes

Plate Volts, D-C.....	1000	1250
Plate Current, Zero-Signal, D-C, ma.....	40	40
Plate Current, Max. Signal, D-C, ma.....	230	240
Grid Volts, D-C .....	-175	-225
Grid-to-Grid, Peak A-F, volts.....	340	440
Load Resistance, ohms (per tube).....	1150	1650
Load Resistance, Effective, ohms (plate to plate).....	4600	6600
Max-Signal Power Output, watts.....	75	115

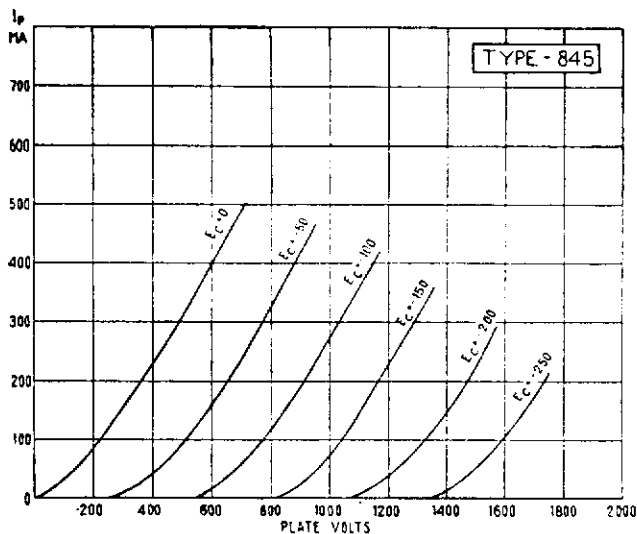



# Taylor

**CUSTOM  
BUILT**

# Tubes



## T-21

21 WATTS

PLATE DISSIPATION  
BEAM TUBE

### \$1.95

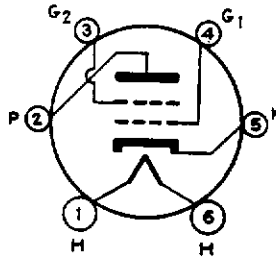

T-21  
Bottom View

The T-21 is a heater cathode type Beam Power Amplifier Tube especially efficient as an oscillator, amplifier or frequency multiplier and desirable for mobile and portable radio transmitters. The electrical characteristics are similar to those of the 6L6G.

#### GENERAL CHARACTERISTICS

Heater Voltage, volts.....	6.3
Heater Current, amps.....	0.9
Amp. Factor.....	138
Max. Plate Dissipation, watts.....	21
Max. Screen Dissipation, watts.....	3.5

#### Overall Dimensions

Max. Length, inches.....	5 3/4
Max. Diameter, inches.....	2 1/8

#### Interelectrode Capacities

Grids to Plate, mmf.....	1.4
Input, mmf.....	11.5
Output, mmf.....	11.5

#### CLASS C AMPLIFIER

Max. Operating Plate, volts.....	400*
Max. D. C. Plate Current—Telegraph, ma.....	95
Max. D. C. Plate Current—Telephone, ma.....	65
Max. D. C. Grid Current, ma.....	5
D. C. Grid, volts.....	-45
Max. Driving Power, watts.....	4
Max. Screen Current, ma.....	16
Max. Screen Voltage.....	300

\* It is recommended that plate voltage be reduced to 300 volts at frequencies above 30 MC.

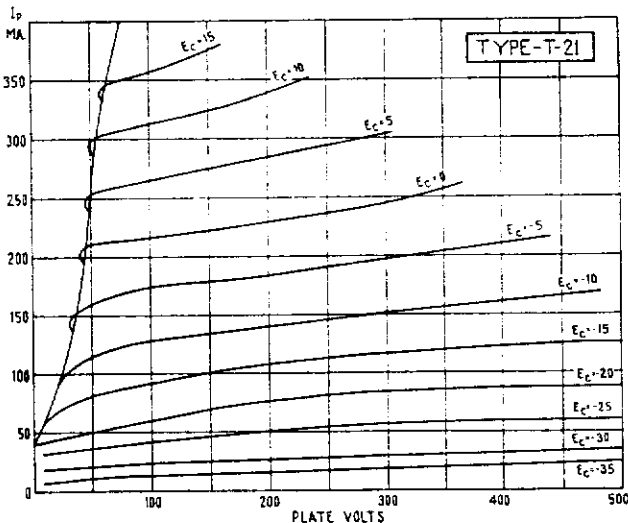

## 282-A

75 WATTS PLATE DISSIPATION  
SCREEN GRID

### \$22.50

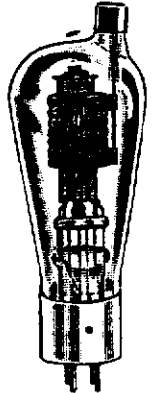

A Taylor designed Screen Grid, R F Power Amplifier and Oscillator Tube which is used in multi-channel Transmitters. The Taylor design features an improved vertical filament—eliminating the sagging that prevailed with the old spiral wound filament. Taylor 282A is used by all the leading airlines.

#### GENERAL CHARACTERISTICS

Fil. Volts .....	1070
Fil. Current, amps.....	3.0
Max. D. C. Plate Volts.....	1000
Max. D. C. Plate Current, ma.....	100
Max. D. C. R. F. Grid Current, amps.....	5
Max. D. C. Screen Grid Volts.....	150
Max. D. C. Grid Volts.....	-90
Amp. Factor .....	100
Max. Size.....	6 3/4 in. high, 2 1/4 diameter
	UX 4 Prong Base
	Nonex Glass

### IMPORTANT INFORMATION

**TESTING TUBES:** As many of the tubes returned to us as defective test out OK here we want to make some suggestions that will enable every user to give doubtful tubes a partial emission test in his own transmitter. Most users have or can easily obtain a 6.3 volt or 10 volt transformer. In the case of testing a tube which has a 7.5 volt filament, replace the 7.5 volt transformer with a 6.3 volt transformer. Then, without making any other changes, note the readings of the meters in the grid and plate circuits of the tube being tested. There should be only a slight drop in the plate current while the grid current may drop to 1/2 its former value and the tube would still be satisfactory condition. Should the grid current drop in excess of 1/2 the original value the filament emission can be considered as below normal and the tube should be returned to us for inspection.

In the case of 10 volt tubes when the filament voltage is dropped to 7.5 volts by substituting transformer, the grid current can be expected to drop to approximately 1/2 the normal value. Should the grid current drop in excess of 1/4 the original reading the tube can be considered as having low filament emission.

The above information is based on tubes being operated as class C amplifiers with the normal rated plate current flowing. Should a tube become defective for reasons other than filament emission such as glass failure or element lead wires damage the cause should be determined before replacing with a new tube. Glass failure in the case of tube with both grid and filament leads brought out through one press is usually caused by; excessive grid voltage, excessive R.F. grid current or approaching the upper frequency limit of practical operation without reducing the power input. In the case of plate leads the glass may be cracked from excessive R.F. current. The R.F. current in the plate lead increases directly with frequency and is particularly destructive in cases where V.H.F. parasitic oscillation are present.

*Experience has proven to us that transmitting tubes can not be shipped via Parcel Post with safety. When tubes are returned for inspection pack the tubes very carefully and ship via Express.*

### CIRCUIT INFORMATION

A circuit employing the 813 in plate-modulated telephony service is shown on this page. In this circuit it will be noted that the plate-circuit by-pass condenser  $C_6$  is connected to ground in series with screen by-pass  $C_7$ . This arrangement minimizes the by-passing effect of  $C_6$  at high audio frequencies and greatly improves the modulation of the screen voltage. Because the screen impedance of the 813 is about 20000 ohms and the series screen resistor required is 60000 ohms, the capacitance ratio of  $C_6$  to  $C_7$  should be about 3 to 1, as indicated in the legend. For operation at 3.5 Mc and lower frequencies, it may be desirable to increase the values of  $C_6$  and  $C_7$ , keeping their ratio the same.

In Class C telegraph service, where the grid excitation or the cathode circuit of the 813 is to be keyed, it is important that the screen voltage be obtained from a separate, low-voltage source, or from a tap on a bleeder circuit across the plate supply. It should not be obtained through a series resistor as shown in the plate-modulated-telephony circuit. With the series-resistor method, the D. C. screen voltage will rise to the plate potential when the space current is reduced to zero. This voltage, of course, greatly exceeds the maximum screen-voltage rating. When the D. C. screen voltage is limited to approximately 400 volts under key-up conditions, a fixed grid bias of -45 or -50 volts is adequate to reduce the plate current to a safe value; partial fixed bias, therefore, is recommended in C. W. transmitters where the oscillator stage is to be keyed for break-in operation. The remainder of the required grid bias can be conveniently obtained from a grid leak.



## 813 BEAM POWER AMPLIFIER \$22.00

The Taylor 813 is a Beam Power Transmitting Tube requiring less than one watt of driving power to 260 watts output; 100 watts plate dissipation. Ideal for use in quick band-change transmitters, as neutralization is not necessary in well shielded units. The 813 is an excellent doubler—gives strong harmonic output with very high efficiency. Has molded glass-dish type stem. As a result of short leads, the 813 can be operated at full input at 30 mc., and at reduced ratings up to 60 mc.

### GENERAL CHARACTERISTICS

Filament Voltage	.....	10.0
Filament Current, amps.	.....	5.0
Transconductance, for Plate Current of 50 ma., approx.	.....	3750

### Interelectrode Capacitances:

Grid-Plate (with External Shielding), max., uuf.....	0.2
Input, uuf.....	16.3
Output, uuf.....	14
Max. Height, in. ....	2 1/8
Max. Diam., in. ....	7 1/2
7 Prong Jumbo Base	Nonex Glass

### MAXIMUM RATINGS AND TYPICAL OPERATING CONDITIONS As Plate-Modulated R-F Power Amplifier—Class C Telephony

	C.C.S.
D. C. Plate Voltage, max. volts.....	1600
D. C. Screen Voltage, max. volts.....	400
D. C. Grid Voltage, max. volts.....	-300
D. C. Plate Current, max. ma.....	150
D. C. Grid Current, max. ma.....	25
Screen Input, max. watts.....	15

### Typical Operation:

D. C. Plate Voltage, volts.....	1250	1600
D. C. Screen Voltage, § volts.....	400	400
From a series screen resistor, ohms.....	53000	60000
D. C. Grid Voltage,* volts.....	-120	-130
From a grid resistor of, ohms.....	30000	21600
Peak R-F Grid Voltage, volts.....	195	210
Beam-Forming Plate Voltage, ‡ volts.....	0	0
D. C. Plate Current, ma.....	150	150
D. C. Screen Current, ma.....	16	20
D. C. Grid Current (approx.), ma.....	4	6
Driving power (approx.), watts.....	0.7	1.2
Power Output (approx.), watts.....	135	175

### As R-F Power Amplifier and Oscillator—Class C Telephony. C.C.S.

D. C. Plate Voltage, max. volts.....	2000
D. C. Screen Voltage, max. volts.....	400
D. C. Grid Voltage, max. volts.....	-300
D. C. Plate Current, max. ma.....	180
D. C. Grid Current, max. ma.....	25
Screen Input, max. watts.....	22

### Typical Operation:

D. C. Plate Voltage, volts.....	1250	1500	2000
D. C. Screen Voltage, volts.....	300	300	400
From a series resistor of, † ohms.....	42000	60000	107000
D. C. Grid Voltage, volts.....	-60	-70	-90
From a grid resistor of,* ohms.....	8500	11700	30000
Peak R-F Grid Voltage, volts.....	145	150	160
Beam-Forming Plate Voltage, ‡ volts.....	0	0	0
D. C. Plate Current, ma.....	180	190	185
D. C. Screen Current, ma.....	23	20	15
D. C. Grid Current (approx.), ma.....	7	6	3
Driving Power (approx.), watts.....	1	0.8	0.5
Power Output (approx.), watts.....	155	190	260

†Series screen resistor should not be used except where the 813 is employed as a buffer amplifier and is not keyed.

‡Beam-forming plates should be connected to the mid-point of filament circuit operated on A. C., or to the negative end of the filament when a D. C. filament supply is used.

§Supplied preferably from separate modulated screen-voltage source; voltage-dropping resistor in series with modulated plate-voltage supply may be used.

\*The total effective grid-circuit resistance should not exceed 30000 ohms.

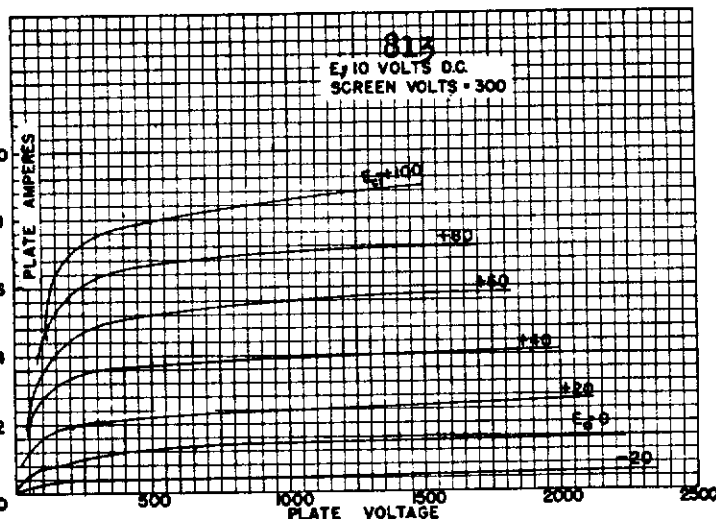
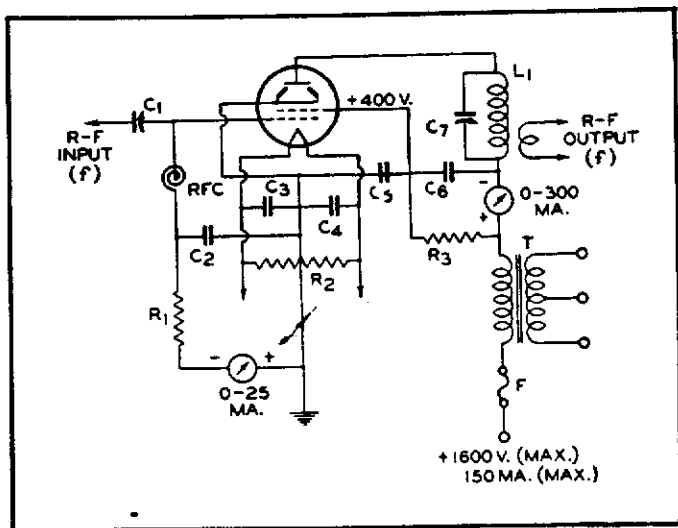

# Taylor

**CUSTOM  
BUILT**

# Tubes

**R-F POWER AMPLIFIER AND OSCILLATOR PENTODE,  
CLASS C**

**Key-Down Conditions Per Tube Without Modulations**

Plate Volts, D. C.	1250	1500	2000
Plate Current, D. C., milliamperes	160	160	160
Grid Bias, Volts, D. C., or.....	-90	-90	-90
From Cathode Resistor, ohms,			
or .....	415	415	415
From Grid Resistor, ohms....	7500	7500	7500
Grid Volts, Peak R-F.....	175	175	175
Grid Current, D. C., milliamperes	12	12	12
Screen Volts, D. C.....	500	500	500
Screen Current, D. C., milliamperes.....	45	45	45
Screen Resistor.....	Not Recommended		
Suppressor Volts, D. C.....	40	40	40
Driving Power, watts.....	2	2	2
Power Output, watts.....	130	160	210



## 803

PENTODE

125 WATT PLATE DISSIPATION

## \$25.00

**GENERAL CHARACTERISTICS**

Filament Voltage, volts.....	10
Filament Current, amps.....	5
Transconductance, $I_p$ of 62.5 Ma., umhos.....	4000
Capacitance, Grid-Plate (with external shielding), max. uuf.....	0.15
Capacitance, Input, uuf.....	17.5
Capacitance, Output, uuf.....	29

**R-F POWER AMPLIFIER AND OSCILLATOR TETRODE,  
CLASS C**

**Grids No. 2 and No. 3 Connected Together**

**Key-Down Conditions Per Tube Without Modulations**

**TYPICAL OPERATION**

Plate Volts, D. C.	1250	1500	2000
Plate Current, D. C., milliamperes.....	160	160	160
Grid Bias, Volts, D. C., or.....	-90	-90	-90
From Cathode Resistor, ohms.....	445	445	445
From Grid Resistor, ohms.....	3200	3300	3500
Grid Volts, Peak R-F.....	190	190	190
Grid Current, D. C., ma.....	28	27	26
Screen Volts, D. C.....	150	150	150
Screen Current, D. C., milliamperes.....	15	15	15
Screen Resistor.....	Not Recommended		
Driving Current, watts.....	4.6	4.4	4.4
Power Output, watts.....	130	160	210

**NOTES**

\*Grid Voltages are given with respect to the mid-point of filament operated on A. C.; if D. C. is used, each stated value of grid voltage should be decreased by 7 volts and the circuit returns connected to the negative end of the filament.

†Connected to modulated plate-voltage supply or modulated fixed supply through resistor.

‡Preferably connected to unmodulated plate-voltage supply through resistor.

§Modulation essentially negative may be used if the positive peak of the audio-frequency envelope does not exceed 115% of the carrier conditions.

**SUPPRESSOR-MODULATED R-F POWER AMPLIFIER PENTODE,  
CLASS C**

**Carrier Conditions Per Tube for Use With a Maximum  
Modulation Factor of 1.0**

**TYPICAL OPERATION**

Plate Volts, D. C.	1250	1500	2000
Plate Current, D. C., milliamperes.....	100	100	80
Grid Bias, Volts, D. C., or.....	-110	-100	-100
From Grid Resistor, ohms.....	5000	5000	7000
Grid Volts, Peak R-F.....	200	190	170
Grid Current, D. C., milliamperes.....	22	20	15
Screen Resistor, ohms†.....	13000	17000	35000
Screen Current, D. C., milliamperes.....	70	70	48
Suppressor Volts, D. C.....	-70	-90	-110
Suppressor Volts, Peak A-F.....	110	130	150
Driving Power, watts.....	4	3.5	2.5
Power Output, watts.....	40	50	53

**PLATE MODULATED R-F POWER AMPLIFIER PENTODE,  
CLASS C**

**Carrier Conditions Per Tube for Use With a Maximum  
Modulation Factor of 1.0**

**TYPICAL OPERATION**

Plate Volts.....	1250	1600
Plate Current, D. C., milliamperes.....	150	150
Grid Bias, Volts, D. C., or.....	-80	-80
From Grid Resistor, ohms.....	4000	4000
Grid Volts, Peak R-F.....	180	180
Grid Current, D. C., milliamperes.....	20	20
Screen Volts, D. C., or.....	400	500
Screen Resistor, ohms.....	16000	20000
Screen Current, D. C., milliamperes.....	55	55
Suppressor Volts, D. C.....	100	100
Driving Power, watts.....	4	4
Power Output, watts.....	125	155

**PLATE MODULATED R-F POWER AMPLIFIER TETRODE,  
CLASS C**

**Grids No. 2 and No. 3 Connected Together  
Carrier Conditions Per Tube for Use With a Maximum  
Modulation Factor of 1.0**

**TYPICAL OPERATION**

Plate Volts, D. C.	1250	1600
Plate Current, D. C., milliamperes.....	150	150
Grid Bias Volts, D. C., or.....	-180	-180
From Grid Resistor, ohms.....	4000	4000
Grid Volts, Peak R-F.....	305	320
Grid Current, D. C., milliamperes.....	45	45
Screen Volts, D. C., or.....	130	130
Screen Resistor, ohms†.....	15000	20000
Screen Current, D. C., milliamperes.....	75	75
Driving Power, watts.....	15	15
Power Output, watts.....	125	155

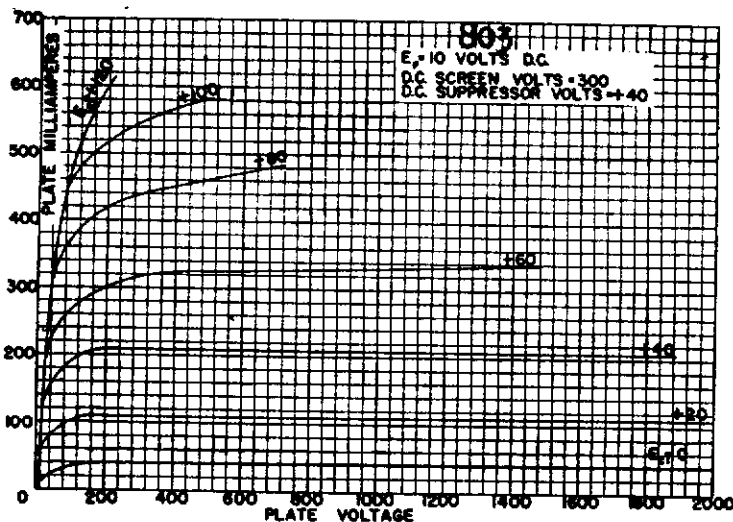



## 838

**ZERO BIAS CLASS B MODULATOR**  
**100 WATTS PLATE DISSIPATION**

**\$10.50**

Taylor 838 is a high- $\mu$  triode especially designed for zero-bias modulator service. As an R F power Amplifier, the 838 may be used at maximum ratings at frequencies up to 30 mc.

**GENERAL CHARACTERISTICS**

Filament Voltage (A.C. or D.C.), volts.....	10.0
Filament Current, amps.....	3.25
Direct Interelectrode Capacitances:	
Grid-Plate, uuf.....	8
Grid-Filament, uuf.....	6.5
Plate-Filament, uuf.....	5
MAXIMUM HEIGHT.....	7 $\frac{3}{8}$ "
MAXIMUM DIAMETER.....	2 $\frac{1}{8}$ "

**TYPICAL OPERATING CONDITIONS**

As A-F Power Amplifier and Modulator—Class B

Unless Otherwise Specified, Values Are for 2 Tubes

D-C Plate Voltage, volts.....	1250
D-C Grid Voltage, volts.....	0
Peak A-F Grid-to-Grid Voltage, volts.....	200
Zero-Sig. D-C Plate Current, ma.....	148
Max. Sig. D-C Plate Current, ma.....	320
Load Resistance (per tube), ohms.....	2250
Effective Load Resistance (plate-to-plate), ohms.....	9000
Max-Sig. Driving Power (approx.), watts.....	7.5
Max-Sig. Power Output, watts.....	260

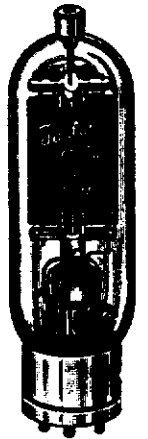
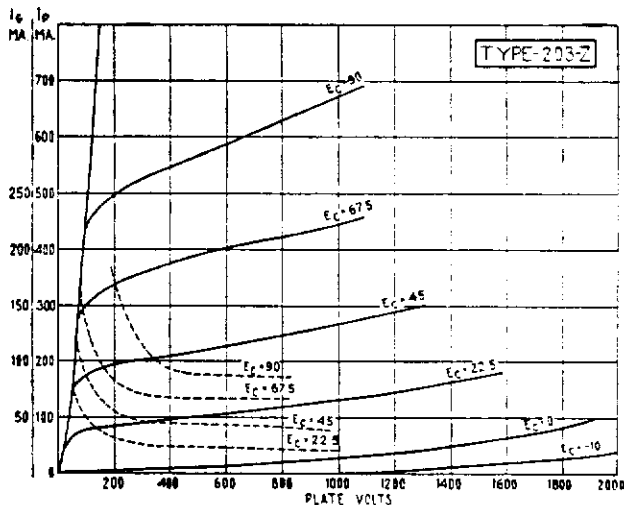

## 203-Z

**ZERO BIAS TUBE**  
**65 WATTS PLATE DISSIPATION**  
*Nickel Anode*

**\$8.00**

**300 WATTS CLASS B OUTPUT**

**GENERAL CHARACTERISTICS**

Filament Volts.....	10
Filament Current, amps.....	3.25
Amplification Factor.....	85
Plate Dissipation, watts.....	65

**Overall Dimensions**

Maximum Length, inches.....	8 $\frac{1}{4}$
Maximum Diameter, inches.....	2 $\frac{1}{8}$
<b>50 Watt Base</b>	<b>Nonex Glass</b>

**CLASS B AUDIO**

Maximum Ratings

D. C. Plate Volts.....	1250
D. C. Plate Current, ma.....	175
Plate Dissipation, watts.....	65

**Typical Operating Conditions for Two Tubes**

D. C. Plate Volts.....	1000	1250
D. C. Plate Current, ma. (max. signal).....	350	350
D. C. Plate Current, ma. (zero signal).....	60	50
D. C. Grid Bias Volts.....	0	-4.5
Power Output, watts.....	230	300
Driving Power, watts.....	6.5	6.75
Peak Grid to Grid, volts.....	206	215
Plate to Plate Load, ohms.....	6200	6000

**CLASS B AUDIO DATA**

The chart below gives the maximum average value as would be indicated on the plate current meter with sine wave input. For the same peak output with voice input the maximum average plate current will be approximately 50 to 60 per cent of this value.

Supply Voltage ↓	150	200	250	300	Audio Watts ←Output
1250	170 17500 135 2.5	230 12500 165 3.9	300 9500 195 5.6	350 8000 215 6.75	←Max. Av. Ip. ←Plate to Plate load ←Grid to Grid Volts ←Watts drive
1100	200 12700 149 3.1	270 9000 183 5.0	350 7000 215 6.75	←Max. Av. Ip. ←Plate to Plate load ←Grid to Grid Volts ←Watts drive	
1000	220 10000 150 3.4	320 6900 203 6.4	←Max. Av. Ip. ←Plate to Plate load ←Grid to Grid Volts ←Watts drive		
900	250 7900 164 4.1	350 5400 206 6.5	←Max. Av. Ip. ←Plate to Plate load ←Grid to Grid Volts ←Watts drive		

# Taylor

**CUSTOM  
BUILT**

# Tubes

## T-20

GENERAL PURPOSE TRIODE

20 WATTS PLATE DISSIPATION

**\$2.25**



### GENERAL CHARACTERISTICS

Filament Volts .....	7.5
Filament Current, amps.....	1.75
Amplification Factor .....	20
Plate Dissipation, watts.....	20

### Interelectrode Capacities

Grid-plate, mmf .....	5.05
Grid-filament, mmf .....	4.85
Plate-filament, mmf.....	0.65

### Overall Dimensions

Maximum length, inches.....	6
Maximum diameter, inches.....	.24

UX 4-prong Alsimag Base

The T20 is recommended as an extremely fine amplifier tube on all frequencies up to 60 MC. Nearly 30,000 T20's and TZ20's combined have been bought by Amateurs throughout the world and daily we receive enthusiastic reports of long life and highly efficient performance. T20's and TZ20's require a minimum amount of excitation and their ratings are conservative. While the rated plate dissipation is 20 watts, no color shows on the plate until the dissipation amounts to approximately 32 watts and it takes about 45 watts to cause a cherry red spot in the center of the plate.

**CAUTION:** Taylor T20's and TZ20's have nickel plates and due to the much lower temperature at which this material will melt, they do not have the same high standard of SAFETY FACTOR that is a feature of Taylor Tubes using carbon anodes. The Safety Factor of T20's and TZ20's is approximately 80 watts. This does not mean that they will be any less efficient but it does mean they will not stand as much abuse. The plate voltage should be reduced while making adjustments to prevent excessive heating. Properly handled, the efficiency of these tubes will be as great as though they had carbon anodes and their life will be equally as long.

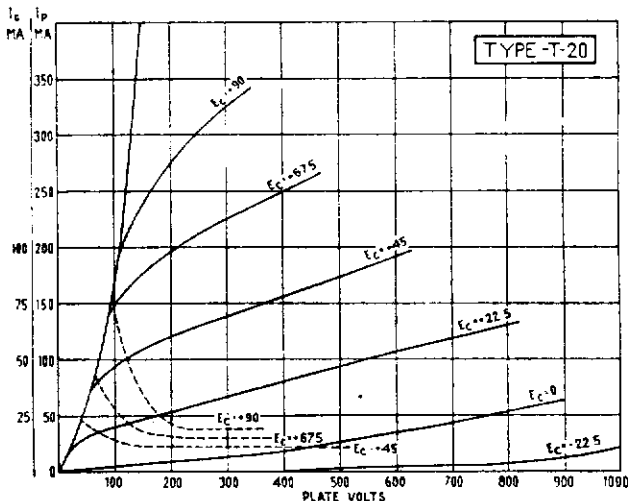

### CLASS C TELEGRAPHY

#### Maximum Ratings

D. C. Plate Volts .....	750
D. C. Plate Current, ma.....	85
D. C. Grid Current, ma.....	25
D. C. Grid Volts .....	200
Plate Dissipation, watts.....	20

#### Typical Operating Conditions

D. C. Plate Volts .....	750
D. C. Plate Current, ma.....	85
D. C. Grid Current, ma.....	18
D. C. Grid Bias Volts.....	-85
From grid leak of, ohms.....	4722
Or { Fixed supply of, volts.....	40
From { Plus grid leak of, ohms.....	2500
Plate Dissipation, watts.....	20
Power Output, watts.....	44
Driving Power, watts.....	3.6

### CLASS C TELEPHONY

#### Maximum Ratings

D. C. Plate Volts .....	750
D. C. Plate Current, ma.....	75
D. C. Grid Current, ma.....	25
D. C. Grid Volts .....	200
Plate Dissipation, watts.....	15

#### Typical Operating Conditions

D. C. Plate Volts .....	750
D. C. Plate Current, ma.....	70
D. C. Grid Current, ma.....	15
D. C. Grid Bias Volts.....	-135
From grid leak of, ohms.....	9000
Or { Fixed supply of, volts.....	40
From { Plus grid leak of, ohms.....	6250
Plate Dissipation, watts.....	15
Power Output, watts.....	38
Driving Power, watts.....	3.6

## TZ-20

**ZERO BIAS TRIODE**

**20 WATTS PLATE DISSIPATION**

**\$2.25**



The TZ20 is primarily designed for zero bias Class B audio operation and no bias is required for such operation at voltages up to 800. It is the ideal Class B audio tube for outputs up to 80 watts and 4 of them push pull parallel will form a most economical 160 watt modulator. For pushpull parallel operation the reflected load impedance will be half and the output twice that for two tubes. The Class B operating conditions for the T20 and TZ20 are identical but the TZ20 avoid the necessity for a source of grid bias with good voltage regulation. At 800 volts the no-signal plate current to a pair of TZ20's will be approximately 25 to 30mA.

The chart below gives proper Class B Audio operating conditions for various outputs at different plate voltages. The most important value is the reflected load impedance which is given for the entire primary or plate to plate. The current value is the maximum average value as would be indicated on the plate current meter with sine wave input. For the same peak output with voice input the maximum average plate current will be approximately 50% to 60% of this value. The TZ20 requires no bias voltage.

D.C. Plate Voltage ↓	40	50	60	70	←Audio Watts Output
800	78MA 21,000	96MA 17,000	117MA 14,000	137MA 12,000	←Max. Av. Ip. ←Plate to plate Load
700	92MA 15,000	115MA 12,000	140MA 10,000	←Max. Av. Ip. ←Plate to plate load	
600	113MA 10,200	140MA 8,100	←Max. Av. Ip. ←Plate to plate load		

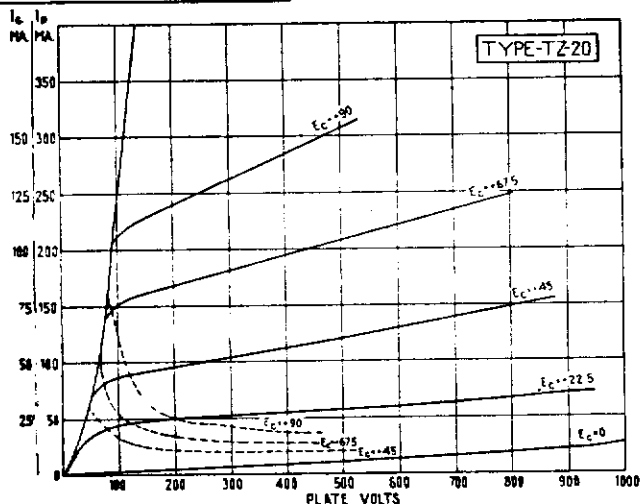

### GENERAL CHARACTERISTICS

Filament Volts .....	7.5
Filament Current, amps.....	1.75
Amplification Factor .....	62
Plate Dissipation, watts.....	20

### Interelectrode Capacities

Grid-plate, mmf .....	4.95
Grid-filament, mmf .....	5.25
Plate Filament, mmf.....	1.0

### Overall Dimensions

Maximum length, inches.....	6
Maximum diameter, inches.....	.234

UX 4-Prong Alsimag Base

### CLASS C TELEGRAPHY

#### Maximum Ratings

D. C. Plate Volts .....	750
D. C. Plate Current, ma.....	85
D. C. Grid Current, ma.....	30
D. C. Grid Volts .....	200
Plate Dissipation, watts.....	20

#### Typical Operating Conditions

D. C. Plate Volts .....	750
D. C. Plate Current, ma.....	85
D. C. Grid Current, ma.....	28
D. C. Grid Bias Volts.....	-40
From grid leak of, ohms.....	1500
Plate Dissipation, watts.....	20
Power Output, watts.....	44
Driving Power, watts.....	3.75

### CLASS C TELEPHONY

#### Maximum Ratings

D. C. Plate Volts .....	750
D. C. Plate current, ma.....	75
D. C. Grid current, ma.....	30
D. C. Grid Volts .....	200
Plate Dissipation, watts.....	15

#### Typical Operating Conditions

D. C. Plate Volts .....	750
D. C. Plate current, ma.....	70
D. C. Grid current, ma.....	23
D. C. Grid Bias Volts.....	-100
From grid leak of, ohms.....	4500
Plate Dissipation, watts.....	15
Power Output, watts.....	38
Driving Power, watts.....	4.8

### CLASS B AUDIO

#### Typical Operating Conditions (for two tubes)

D. C. Plate Volts .....	750
D. C. Plate Current, ma.....	170
D. C. Grid Bias Volts.....	0
Power Output, watts.....	80
Driving Power, watts.....	2.6
Plate to Plate load, ohms.....	9000
Peak A.F. Grid to Grid Volts.....	195

## HD 203-A

150 WATTS PLATE DISSIPATION  
CARBON ANODE TRIODE

**\$14.50**

The Heavy Duty 203A is truly a heavy duty tube and was the first tube designed with the floating anode. Before the introduction of the HD 203A punctures and flashing over in the stems of the standard 203A were very common especially in Class B audio circuits. The HD 203A is a general purpose tube and is used in circuits built for 203A tubes where more power is desired.

**GENERAL CHARACTERISTICS**

Filament Voltage, volts.....	10
Filament Current, amps.....	4
Amplification Factor.....	25
Plate to Grid, mmf.....	12
Thoriated Tungsten Filament—NONEX GLASS	
Maximum Length, inches.....	9½
Maximum Diameter, inches.....	2½

**CLASS "C" AMPLIFIER**

Max. Operating Plate Volts.....	1500	1750
Max. D.C. Plate Current, mls.....	225	225
Max. D.C. Grid Current, mls.....	60	60

**CLASS "B" A.F. MODULATOR**

Push Pull Operation

D.C. Plate Voltage, volts.....	1500	1750
Grid Voltage, appr. volts.....	—45	—67.5
Load Resistance (plt. to plt.) ohms.....	9600	10,000
Max. D.C. Plate Current (2 tubes), mls.....	315	365
Power Output (2 tubes), watts.....	300	400

## 814

200 WATTS PLATE DISSIPATION

**\$18.50**

Low Mu—Ideal for Grid Modulation  
and Class B Linear Operation

The 814 is identical with the 822 except for the Mu or amplification factor and is intended for those applications where a tube of lower mu is desired. The mu of 12 is about optimum for grid modulated and class B linear R.F. operation. We recommend the 814 for efficiency modulated amplifiers.

**CLASS B RADIO FREQUENCY AMPLIFIER**

Typical Operating Conditions

D. C. Plate Volts.....	2000	2500
D. C. Plate Current, A.....	150	.125
Power Output, watts.....	110	115
Grid Bias Volts.....	—165	—200
Peak Driving Power, watts (approx.).....	6	6
Plate Dissipation, watts.....	190	197

For other Operating Data refer to 822 on Page 7

## 841-SW

50 WATTS PLATE DISSIPATION  
CARBON ANODE

A POPULAR DIATHERMY TUBE

**\$8.00**

The Taylor 841-SW has been used for the last ten years by many of the leading diathermy apparatus manufacturers.

**GENERAL CHARACTERISTICS**

Filament Voltage, volts.....	10
Filament Current, amps.....	2
Amplification Factor.....	14.6
Maximum Length, inches.....	6¼
Maximum Diameter, inches.....	2¾
Plate to Grid, mmf.....	9
Alsmag UX Base—NONEX GLASS	

**CLASS "C" OSC AND POWER AMP**

Max. Operating Plate Volts	
Unmodulated D.C., volts.....	1000
Max. D.C. Plate Current, mls.....	150
Max. D.C. Grid Current, mls.....	30
Max. Plate Dissipation, watts.....	50
Max. RF Grid Current, amps.....	5

## HD 211-C

150 WATTS PLATE DISSIPATION  
CARBON ANODE

**\$14.50**

Used in Diathermy equipment where voltage is limited so that higher current is permissible to obtain rated output.

**GENERAL CHARACTERISTICS**

Filament Voltage, volts.....	10
Filament Current, amps.....	4
Mutual Conductance, $\mu$ Mhos.....	4300
Amplification Factor.....	12
50 Watt Base	Nonex Glass
Max. length.....	9½ in.
Max. diameter.....	2½ in.

**INTERELECTRODE CAPACITIES**

Plate to Grid, mmf.....	9
Grid to Filament, mmf.....	5
Plate to Filament, mmf.....	4

**CLASS "C" OSC. AND POWER AMP.**

Max. Operating Plate Volts.....	2000
Max. D.C. Plate Current, mls.....	225
Max. D.C. Grid Current, mls.....	60
Max. Plate Dissipation, watts.....	150
Max. R.F. Grid Current, amps.....	7.5
Max. R.F. Output, watts.....	250

# Engineering Cooperation

Taylor Tubes really welcomes the opportunity to work with your engineers on any problems involving Power or Rectifier Tubes of the types listed in this catalog. We have worked closely with the engineers of many leading industrial concerns to our mutual advantage. We can quickly build sample tubes to your own specifications at a reasonable cost. You can count on close cooperation at TAYLOR TUBES.

---

**TAYLOR TUBES, Inc.**  
2312-18 Wabansia Avenue  
Chicago 47, Illinois  
Telephone ARMitage 1730

---

Foreign Representative  
**ROYAL NATIONAL CO.**  
Cable NATVARNCO  
89 Broad Street  
New York 4, N. Y.

**TUBES WITH A REAL GUARANTEE**